

# **Pulsed/CW NMR Spectrometer**

## **PS2-A/B/C INSTRUCTOR'S MANUAL**

**A PRODUCT OF TEACHSPIN, INC.**

TeachSpin, Inc.  
2495 Main Street Suite 409 Buffalo, NY 14214-2153  
Phone: (716) 885-4701  
Fax: (716) 836-1077  
[WWW.TeachSpin.com](http://WWW.TeachSpin.com)

# TeachSpin Inc.

## PULSED/CW NMR SPECTROMETER

### INSTRUCTOR'S MANUAL INDEX

#### Introduction

- Overview of the Instrument I-1
- Outline of the Physics I-2
- References I-14

#### The Instrument

- Receiver Module II-1
- 21 MHz Synthesizer II-7
- Pulse Programmer II-8
- Lock-In, Sweep Module II-9
- The Permanent Magnet II-12
- Magnetic Field Gradient Coils II-16
- Magnet Yoke Adjustment II-17
- Modulation Coils II-18
- RF Sample Probe Head II-19
- Pick-Up Probe II-21

#### Getting Started

- Spectrometer Set Up – Pulse Mode III-1
- Digital Setting of Parameters III-2
- Single Pulse Experiments III-5
- Two Pulse Experiments III-13
- Continuous Wave (CW) Experiments III-17

#### Experiments

- Experiments Listed IV-1
- Imaging Experiments\* V-1

#### Appendices

- Specifications Page
- Conceptual Tour
- Safety Data Sheets

\* PS2A and B will require replacement of the rf coil in the RF Sample Probe Head to perform the Imaging Experiments described in Chapter V.

# I. INTRODUCTION

## A. OVERVIEW OF THE INSTRUMENT

Congratulations, you have acquired for your students the most versatile, sensitive, rugged and reliable nuclear magnetic resonance spectrometer designed specifically for instruction. The specifications of this unit rival any research grade unit in this frequency range in terms of sensitivity, stability, capabilities and state-of-the-art electronics. And yet, the unit was designed from the outset for student instruction. By that we mean that students, and not a computer, set all of the experimental parameters. Students can make many mistakes including miswiring the spectrometer and incorrectly setting any and all of the parameters without damaging the unit. For the one case where incorrect wiring might do some damage, the unit has special connectors which make those connections impossible with the cables provided.

All of the data is presented in analog form for examination on a digital storage oscilloscope or a computer. Students (and faculty) can then choose how they wish to perform data reduction or analysis. No proprietary software programs are needed to operate the unit, so no software updates are needed. TeachSpin is convinced that the “volt” will never go out of style, and that the mode of data storage and analysis is a choice best left to the individual user. Although data storage and analysis hardware and software is changing so rapidly that what is “hot” today may be obsolete tomorrow, your TeachSpin spectrometer, with its analog output signals, will be capable of taking research grade data long into the future.

Our first NMR instrument PS1-A,B is no longer available because some of its essential electronics components are no longer being manufactured. (It continues, however, to teach students pulsed NMR spectroscopy of protons at more than 170 institutions all over the world.) PS2 is a completely redesigned spectrometer. The many differences and innovations are presented in the following list.

1. Students can study NMR signals from **two** types of nuclei, protons (hydrogen nuclei) and fluorine. Since the field of the permanent magnet is constant, this is accomplished by changing the spectrometer frequency.
2. PS2 is both a pulsed and a continuous wave (CW) spectrometer.
3. The unit has both amplitude (envelope) and phase sensitive detection built into its receiver.
4. The RF probe head has a single coil and a 50  $\Omega$  input impedance; a matched unit.
5. The field and frequency have increased to 21 MHz proton for resonance.
6. The magnetic field is stabilized to 1 part in  $2 \times 10^6$  over a 20 minute interval.
7. Adjustable electric shim coils that can be used to increase the magnetic field homogeneity are part of the RF sample probe system. They can also be used to create known gradients for measuring diffusion as well as for one-dimensional imaging.
8. The homogeneous high magnetic field allows direct detection of inequivalent fluorine and protons nuclei (chemical shifts) in the free induction decay signal.

9. A Lock-In detection module can detect CW signals from solids with wide lines.
10. Both magnetic field and RF frequency sweeps are built in for studying CW resonance.
11. Digital clock stability in both the RF frequency and the pulse width synthesis are integral to the design.
12. The receiver recovery time (after pulse) has been improved by a factor of five to approximately 15  $\mu$ s, making signals from “soft” solids available for study.
13. An elongated sample coil and layered sample kit, designed for PS2-C in 2013, allows students to perform one-dimensional imaging on samples of up to five layers. (A retrofit kit is available for both PS-A and PS1-B.)

The electronics system was designed by Dr. Norman Jarosik of the Princeton University Physics Department. Norman is a staff scientist in the “gravity Group” and the chief engineer of WMAP, the satellite that has been sensing and mapping the anisotropies in the microwave radiation left over from the Big Bang of the early universe. He also designed the PS-1 A and B whose well deserved reputation for reliability, as well as sensitivity, is known world-wide. Norman has been involved with TeachSpin from its 1992 inception.

Nuclear magnetic resonance is a large and mature field of physics. There certainly is a lot to learn and a real potential for a student to explore his or her own ideas in this area, perhaps even to find a real research project. We cannot think of a better instrument for students to pursue their own open-ended sets of experiments. But a new student should not be intimidated by the prospect of learning this vast subject. TeachSpin has outlined a manageable way to begin the study of NMR. Students can begin with straight-forward experiments that will develop their confidence and understanding and then branch out to more advanced measurements. This instrument is accessible, after all, it was designed from the moment of inception for the student. Enjoy!

## **B. OUTLINE OF THE PHYSICS**

### **B.1 Brief History**

In 1946, nuclear magnetic resonance (NMR) in condensed matter was discovered simultaneously by Edward Purcell at Harvard and Felix Bloch at Stanford using different instrumentation and techniques. Both groups, however, placed a sample containing magnetic nuclei in a uniform magnetic field and observed the response of those nuclei to a continuous (CW) radio frequency magnetic field as the field was tuned through resonance. This discovery opened up a new type of spectroscopy which has become one of the most important tools available to physicists, chemists, geologists, and biologists.

In 1950, Erwin Hahn, a postdoctoral fellow at the University of Illinois, again placing his sample of condensed matter in a uniform magnetic field, explored the response of the magnetic nuclei to pulse bursts of these same radio frequency (RF) magnetic fields. Hahn was interested in observing transient effects on the magnetic nuclei after the RF bursts. During these experiments, he observed a “spin echo” signal; that is, a signal from the magnetic nuclei that occurred after a two pulse sequence, at a time equal to the delay time between the two pulses. This discovery, and his brilliant analysis of the experiments, gave birth to a new technique for studying magnetic resonance. This pulse method originally had only a few practitioners, but now it is the method of choice for most laboratories. For the first twenty years after its discovery, continuous wave (CW) magnetic

resonance apparatus was used in almost every research chemistry laboratory, and no commercial pulsed NMR instruments were available. However, since 1966 when Ernst and Anderson showed that high resolution NMR spectroscopy can be achieved using Fourier transforms of the transient response, and cheap fast computers made this calculation practical, pulsed NMR has become the dominant commercial instrumentation for most research applications.

Widely used in physics and chemistry to characterize materials, NMR is a microscopic method in the sense that it probes the nuclei and their immediate surroundings. Within a certain solid, for instance, there may be a variety of local magnetic fields. A magnetic measurement by a magnetometer measures an average field. NMR, on the other hand, is capable of measuring the local field at atomic nuclei. Another example would be a molecule containing a several atoms of the same element, for instance carbon, in various different configurations. The NMR signal will be different for each one of these configurations. The microscopic nature of the NMR measurement makes it extremely useful, and often unique. Of course, in order to have a signal of detectable magnitude, we need many molecules of the same configuration to occur within the sample. The nuclei investigated in this set of experiments, hydrogen (proton) and fluorine, are very abundant and give particularly strong signals.

This technology has also found its way into medicine. MRI (magnetic resonance imaging; the word “nuclear” being removed to relieve the fears of the scientifically illiterate public) scans are revolutionizing radiology. This imaging technique seems to be completely noninvasive, produces remarkable three dimensional images, and has the potential to give physicians detailed information about the inner working of living systems. For example, preliminary work has already shown that blood flow patterns in both the brain and the heart can be studied without dangerous catheterization or the injection of radioactive isotopes. Someday, MRI scans may be able to pinpoint malignant tissue without biopsies. MRI is only in its adolescence, and we will see many more applications of this diagnostic tool in the coming years.

You have purchased a pulsed and CW NMR spectrometer designed specifically for teaching. The PS2 is a complete spectrometer, including the magnet, magnet temperature controller, pulse generator, oscillator, pulse amplifier, sensitive receiver, linear amplitude and phase-sensitive detector, sample probe, gradient coils with dedicated current regulated supply and a CW lock-in detector. You need only supply the oscilloscope and the substances you wish to study. Now you are ready to learn the fundamentals of both CW and pulsed nuclear magnetic resonance spectroscopy.

Nuclear magnetic resonance is a vast subject. Tens of thousands of research papers and hundreds of books have been published on NMR. We will not attempt to explain or even to summarize this literature. Some of you may wish to do only a few simple experiments with the apparatus and achieve a basic conceptual understanding, while others may aim to understand the details of the density matrix formulation of relaxation processes and do some original research. The likelihood is that the majority of students will work somewhere in between these two extremes. In this section we will provide a brief theoretical introduction to many important ideas of PNMR. This will help you get started and can be referred to later. These remarks will be brief, not completely worked out from first principles, and not intended as a substitute for a careful study of the literature and published texts. An extensive annotated bibliography of important papers and books on the subject is provided at the end of this section.

## B.2 Theory

Magnetic resonance is observed in systems where the magnetic constituents have **both a magnetic moment** and **an angular momentum**. Many, but not all, of the stable nuclei of ordinary matter have this property. In “classical physics” terms, magnetic nuclei act like a small spinning bar magnet. For this instrument, we will be concerned with only two nuclei, the nucleus of hydrogen, which is a single proton, and the nucleus of fluorine which contains both protons and neutrons. Both nuclei can be thought of as small spinning bar magnets with a magnetic moment  $\mu$  and an angular momentum  $J$ , which are related by the vector equation:

$$\boldsymbol{\mu} = \gamma \mathbf{J} \quad (1.1)$$

The proportionality factor  $\gamma$  is called the “gyromagnetic ratio” and its values are unique to each kind of nucleus in the experiment.

The nuclear angular momentum is quantized in units of  $\hbar$  as:

$$\mathbf{J} = \hbar \mathbf{I} \quad (1.2)$$

where  $\mathbf{I}$  is the “spin” of the nucleus.

The magnetic energy  $U$  of the nucleus in an external magnetic field is:

$$U = -\boldsymbol{\mu} \cdot \mathbf{B} \quad (1.3)$$

If the magnetic field is in the z-direction, then the magnetic energy is:

$$U = -\mu_z B_0 = -\gamma \hbar I_z B_0 \quad (1.4)$$

Quantum mechanics requires that the allowed values  $I_z$ ,  $m_1$ , be quantized as

$$m_1 = I, I - 1, I - 2, I - 3 \dots -I. \quad (1.5)$$

Both of the nuclei we are investigating, the proton (hydrogen nucleus) and the fluorine nucleus have spin one half ( $I = 1/2$ ). Therefore, the allowed values of  $I_z$  are simply

$$m_1 = \pm 1/2 \quad (1.6)$$

This means that there are only two magnetic energy states for these nuclei when residing in a constant magnetic field  $B_0$ . These states are described in Figure 1.1.

The energy separation between the two states,  $\Delta U$ , can be written in terms of an angular frequency or as

$$\begin{aligned} \Delta U &= \hbar \omega_0 = \gamma \hbar B_0 \\ \text{or} \\ \omega_0 &= \gamma B_0 \end{aligned} \quad (1.7)$$

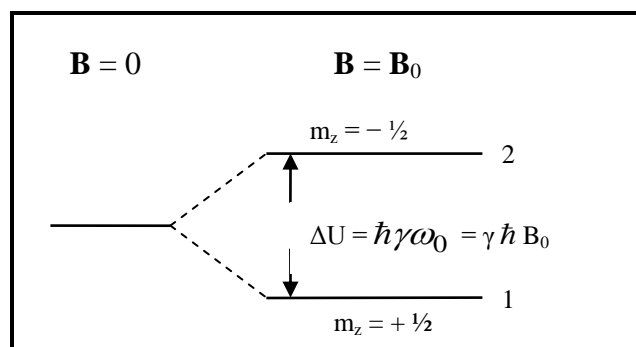

Figure 1.1 Energy State Separation in a Magnetic Field

Equation 1.7,  $\omega_0 = \gamma B_0$  describes the fundamental resonance condition.

For the proton: 
$$\gamma_{\text{proton}} = 2.675 \times 10^8 \text{ rad/sec-tesla} \quad (1.8)$$

For Fluorine: 
$$\gamma_{\text{fluorine}} = 2.517 \times 10^8 \text{ rad/sec-tesla}$$

For the proton, the numerical relationship between the resonant frequency and the constant magnetic field is worth remembering:

$$f_{\text{proton}} (\text{MHz}) = 42.58 B_0 \text{ tesla} \quad (1.9)$$

If a one milliliter (ml) sample of water (containing about  $7 \times 10^{19}$  protons) is placed in a magnetic field in the z-direction, a nuclear magnetization in the z-direction eventually becomes established. This nuclear magnetization occurs because of unequal population of the two possible quantum states. If  $N_1$  and  $N_2$  are the number of spins per unit volume in the respective states, then the population ratio ( $N_2/N_1$ ), in thermal equilibrium, is given by the Boltzmann factor as:

$$\frac{N_2}{N_1} = e^{\frac{\Delta U}{kT}} = e^{\frac{\hbar\omega_0}{kT}} \quad (1.10)$$

and the magnetization is

$$M_z = (N_1 - N_2) \mu \quad (1.11)$$

The thermal equilibrium magnetization per unit volume for N magnetic moments is

$$M_0 = N\mu \tanh\left(\frac{\mu B}{kT}\right) \approx N \frac{\mu^2 B}{kT} \quad (1.12)$$

$$\text{where } N = N_1 + N_2$$

This magnetization does **not** appear instantaneously when the sample is placed in the magnetic field. It takes a finite time for the magnetization to build up to its equilibrium value along the direction of the magnetic field (which we define as the z-axis). For most systems, the z-component of the magnetization is observed to grow exponentially as depicted in Figure 1.2.

The differential equation that describes such a process assumes that the rate of approach to equilibrium is proportional to the difference between the equilibrium value  $M_0$  and the instantaneous value  $M_z(t)$ :

$$\frac{dM_z(t)}{dt} = \frac{M_0 - M_z}{T_1} \quad (1.13)$$

where  $T_1$  is called the spin-lattice relaxation time.

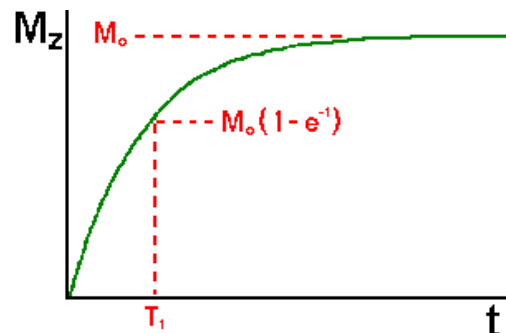

Figure 1.2 Magnetization vs. time for a sample placed in a magnetic field

If the unmagnetized sample is placed in a magnetic field, so that at  $t = 0$ ,  $M_z = 0$ , then direct integration of equation 1.13, with these initial conditions, gives:

$$M_z(t) = M_0(1 - e^{-\frac{t}{T_1}}) \quad (1.14)$$

The rate at which the magnetization approaches its thermal equilibrium value is characteristic of the particular sample. Typical values range from microseconds to seconds. What makes one material take 10 microseconds to reach equilibrium while another material (also with protons as the nuclear magnets) takes 3 seconds? Obviously, some processes in the material make the protons “relax” towards equilibrium at different rates. The study of these processes is one of the major topics in magnetic resonance.

Although we will not attempt to discuss these processes in detail, a few ideas are worth noting. In thermal equilibrium, more protons are in the lower energy state than the upper. When the unmagnetized sample was first put in the magnet, the protons occupied the two states equally that is ( $N_1 = N_2$ ). During the magnetization process energy must flow *from* the nuclei *to* the surroundings, since the magnetic energy from the spins is reduced. The surroundings which absorb this energy are referred to as “the lattice”, even for liquids or gases. Thus, the name “spin-lattice” relaxation time for the characteristic time of this energy flow.

However, there is more than energy flow that occurs in this process of magnetization. Each proton has angular momentum (as well as a magnetic moment) and the angular momentum must also be transferred from the spins to the surroundings during magnetization. In quantum mechanical terms, the “lattice” must have angular momentum states available when a spin goes from  $m_1 = -1/2$  to  $m_1 = +1/2$ . In classical physics terms, the spins must experience a torque capable of changing their angular momentum. The existence of such states is usually the critical determining factor in explaining the enormous differences in  $T_1$  for various materials. Pulsed NMR is ideally suited for making precise measurements of this important relaxation time. The pulse technique gives a direct and unambiguous measurement, where as CW spectrometers require a difficult, indirect, and imprecise technique to measure the same quantity.

What about magnetization in the x-y plane? In thermal equilibrium the only **net** magnetization of the sample is  $M_z$ , the magnetization along the external constant magnetic field. This can be understood from a simple classical model of the system. Think of placing a collection of tiny current loops in a magnetic field. The torque  $\tau$  on the loop is  $\mu \times B$  and that torque causes the angular momentum of the loop to change, as given by:

$$\tau = \frac{d\mathbf{J}}{dt} \quad \text{or} \quad \boldsymbol{\mu} \times \mathbf{B} = \frac{d\mathbf{J}}{dt} \quad (1.15)$$



For our nuclei, equation 1.15 becomes:

$$\boldsymbol{\mu} \times \mathbf{B} = \frac{1}{\gamma} \frac{d\boldsymbol{\mu}}{dt} \quad (1.16)$$

Equation 1.16 is the classical equation describing the time variation of the magnetic moment of the proton in a magnetic field. It can be shown from equation 1.16 that the magnetic moment will execute precessional motion, depicted in 1.3. The precessional frequency  $\omega_0 = \gamma B_0$ , is just the resonant frequency in equation 1.7.

If we add up all the magnetization for the  $10^{20}$  nuclei in our sample in thermal equilibrium, the  $\mu_z$  components sum to  $M_z$ , but the x and y components of the individual magnetic moments add to zero.

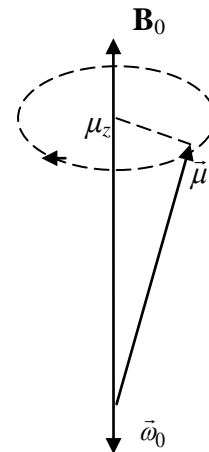

Figure 1.3

For the x-components of every nucleus to add up to some  $M_x$ , there must be a definite phase relationship among all the precessing spins. For example, we might start the precessional motion with the x-component of the spins lined up along the x-axis. But that is not the case for a sample simply placed in a magnet. In thermal equilibrium, the spin components in the x-y plane are oriented randomly. Thus, in thermal equilibrium there is no transverse (x or y) component of the net magnetization of the sample. As we shall soon see, however, there is a way to *create* such a transverse magnetization using radio frequency pulsed magnetic fields. The idea is to quickly rotate the thermal equilibrium magnetization  $M_z$  into the x-y plane and thus create a temporary  $M_x$  and  $M_y$ . Let's see how this is done.

Equation 1.16 can be generalized to describe the classical motion of the net magnetization of the entire sample. It then becomes

$$\frac{d\mathbf{M}}{dt} = \gamma \mathbf{M} \times \mathbf{B} \quad (1.17)$$

where  $\mathbf{B}$  is any magnetic field, including time dependent rotating fields.

Suppose we apply not only a constant magnetic field  $B_0 \hat{k}$ , but a rotating (circularly polarized) magnetic field of angular frequency  $\omega$  the x-y plane so the **total** field is written as <sup>†</sup>

$$\mathbf{B}(\mathbf{t}) = B_1 \cos \omega t \hat{i} + B_1 \sin \omega t \hat{j} + B_0 \hat{k} \quad (1.18)$$

The analysis of the magnetization in this complicated time dependent magnetic field can best be carried out in a non-inertial rotating coordinate system. The coordinate system of choice is rotating at the same angular frequency as the rotating magnetic field with its axis in the direction of the static magnetic field. In this *rotating coordinate system*, the rotating magnetic field appears to be stationary and aligned along the  $x^*$  axis (Figure 1.4). However, from the point of view of the rotating coordinate system,  $B_0$  and  $B_1$  are not the only magnetic fields. An **effective field** along the  $z^*$  direction, of  $-\frac{\omega}{\gamma}\hat{k}^*$  must also be included.

Let's justify this new effective magnetic field with the following physical argument.

Equations 1.16 and 1.17 predict the precessional motion of a magnetization in a constant magnetic field  $B_0\hat{k}$ . Suppose one observes this precessional motion from a rotating coordinate system which rotates **at the precessional frequency**. In this frame of reference the magnetization appears stationary, in some fixed position. The only way a magnetization can remain fixed in space is if there is no torque on it. If the magnetic field is zero in the reference frame, then the torque on  $\mathbf{M}$  is always zero no matter what direction  $\mathbf{M}$  is oriented. The magnetic field is zero (in the rotating frame) if we add the effective field  $-\frac{\omega}{\gamma}\hat{k}^*$

which is equal to  $B_0\hat{k}^*$

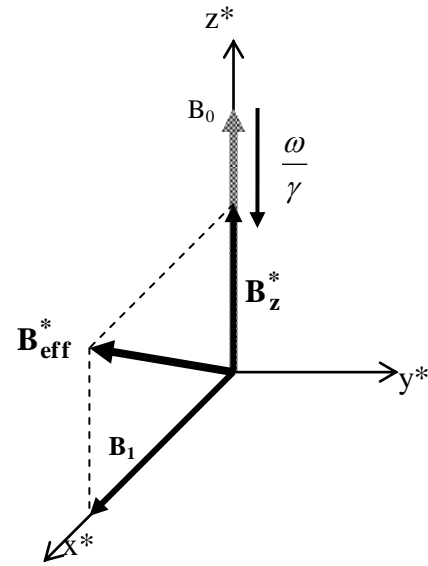

Figure 1.4

Transforming the magnetic field expression in equation (1.18) into such a rotating coordinate system, the total magnet field in the rotating frame  $B^*$  is

$$\mathbf{B}^*_{\text{eff}} = B_1\hat{i}^* + (B_0 - \frac{\omega}{\gamma})\hat{k}^* \quad (1.19)$$

Figure 1.4 is a representation of Equation 1.19. The classical equation of motion of the magnetization as observed in the rotating frame is then

$$\left. \frac{d\mathbf{M}}{dt} \right|_{\text{rot}} = \gamma \mathbf{M} \times \mathbf{B}^*_{\text{eff}} \quad (1.20)$$

which shows that  $\mathbf{M}$  will precess about  $\mathbf{B}^*_{\text{eff}}$  in the rotating frame.

†What is actually applied is an oscillating field  $2B_1 \cos \omega t \hat{i}$ . But that can be decomposed into two counter rotating fields  $B_1(\cos \omega t \hat{i} + \sin \omega t \hat{j}) + B_1(\cos \omega t \hat{i} - \sin \omega t \hat{j})$ . One of the counter rotating fields can be shown to have no practical affects on the spin system and can be ignored in this analysis.

Suppose now, we create a rotating magnetic field at a frequency  $\omega_0$  as such that

$$\frac{\omega}{\gamma} = B_0 \quad \text{or} \quad \omega = \gamma B_0 = \omega_0 \quad (1.21)$$

In that case,  $\mathbf{B}^*_{\text{eff}} = B_1 \hat{i}^*$ , a constant magnetic field in the  $x^*$  direction (Figure 1.5). Then, the magnetization  $M_z$  begins to precess about this magnetic field at a rate  $\Omega = \gamma B_1$ , (in the rotating frame). If we **turn off** the  $B_1$  field at the instant the magnetization reaches the  $x$ - $y$  plane, we will have created a transient (non-thermal equilibrium) situation where there **is** a net magnetization in the  $x$ - $y$  plane. If this rotating field is applied for twice the time the transient magnetization will be  $-\mathbf{M}_z$  and if it is left on four times as long the magnetization will be back where it started, with  $M_z$  along the  $z^*$  axis. These are called:

$$\begin{aligned} 90^\circ \text{ or } \pi/2 \text{ pulse} &\rightarrow M_z \rightarrow M_y \\ 180^\circ \text{ or } \pi \text{ pulse} &\rightarrow M_z \rightarrow -M_z \\ 360^\circ \text{ or } 2\pi \text{ pulse} &\rightarrow M_z \rightarrow M_z \end{aligned}$$

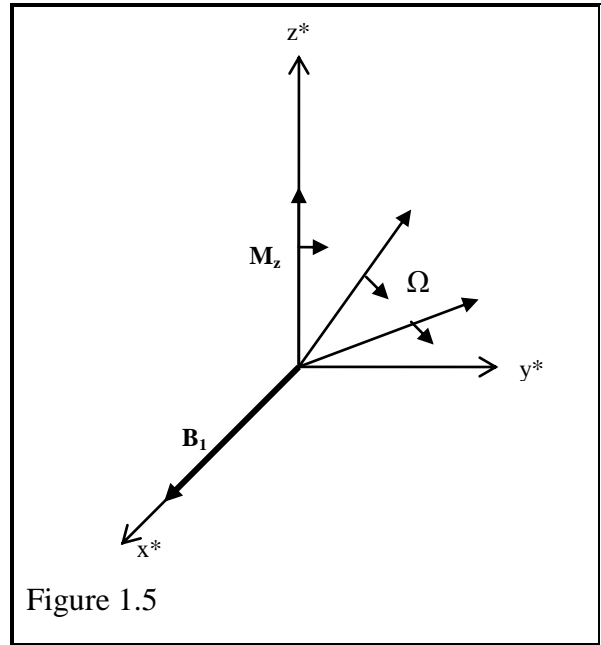

In the laboratory (or rest) frame, where the experiment is actually carried out, the magnetization not only precesses about  $B_1$ , but rotates about  $\hat{k}$  during the pulse. **It is not possible, however, to observe the magnetization during the pulse.** Pulsed NMR signals are observed **AFTER** the transmitter pulse is over? But, what is there to observe **AFTER** the transmitter pulse is over? The spectrometer detects the **net magnetization precessing about the constant magnetic field  $B_0 \hat{k}$  in the  $x$ - $y$  plane. Nothing Else!**

Suppose a  $90^\circ$  ( $\pi/2$ ) pulse is imposed on a sample in **thermal equilibrium**. The net equilibrium magnetization will be rotated into the  $x$ - $y$  plane where, after the pulse, it will precess about  $B_0 \hat{k}$ . But the  $x$ - $y$  magnetization will not last forever. For most systems, this magnetization decays exponentially as shown in Figure 1.6. The differential equations which describe the decay **in the rotating coordinate system are:**

$$\frac{dM_{x^*}}{dt} = -\frac{M_{x^*}}{T_2} \quad \text{and} \quad \frac{dM_{y^*}}{dt} = -\frac{M_{y^*}}{T_2} \quad (1.22)$$

whose solutions are,

$$M_{x^*} = M_0 e^{-\frac{t}{T_2}} \quad \text{and} \quad M_{y^*} = M_0 e^{-\frac{t}{T_2}} \quad (1.23)$$

where the characteristic decay time  $T_2$  is called the **Spin-Spin Relaxation Time**.

One simple way to understand this relaxation process, from the classical perspective, is to recall that each nucleus is itself a magnet and produces a magnetic field at its neighbors. Therefore, for a given distribution of nuclei, there must also be a distribution of *local* fields at the various nucleus sites. Thus, the nuclei precess about  $B_0 \hat{k}$  with a distribution of frequencies, not a single frequency  $\omega_0$ .

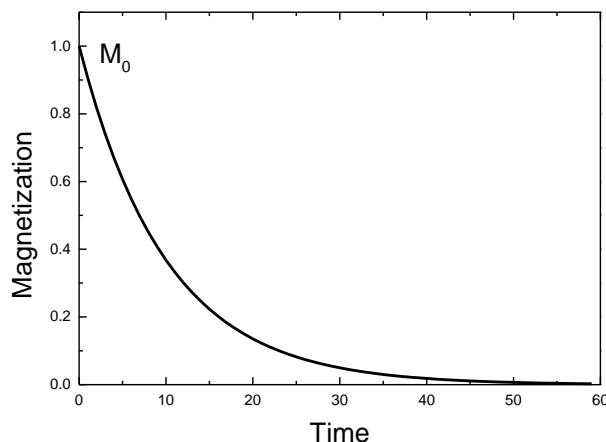

Figure 1.6

Even if all the nuclei begin in phase (after the  $90^\circ$  pulse), they will soon get out of phase and the net x-y magnetization will eventually go to zero. A measurement of  $T_2$ , the decay constant of the x-y magnetization, gives information about the distribution of local fields at the nuclear sites.

From this analysis, it would appear that the spin-spin relaxation time  $T_2$  can be determined by simply plotting the decay of  $M_x$  (or  $M_y$ ) after a  $90^\circ$  pulse. This signal is called the free *precession or free induction decay* (FID). If the field of the magnet were perfectly uniform over the entire sample volume, then the time constant associated with the free induction decay would, in fact, be  $T_2$ . But, in most cases, it is the nonuniformity of the magnet's field over the sample that is responsible for the observed decay constant of the FID. At its center, the PS2 magnet has sufficient uniformity to produce at least a .3 millisecond decay time. Using the electric shim coils (See Section II.F), students can improve the homogeneity so that decay time due to the magnet (called  $T_2^*$  in the jargon) is as long as 5 milliseconds, and, possibly, longer. Thus, for a sample whose  $T_2 < 5$  ms, the free induction decay constant is also the  $T_2$  of the sample. But what if  $T_2$  is actually 5 msec or longer? The observed decay will still be about 5 ms. Here is where the genius of Erwin Hahn's discovery of the spin echo plays its crucial role.

Before the invention of pulsed NMR, the only ways to measure the real  $T_2$  were to improve the magnet's homogeneity and to make the sample smaller. But, PNMR changed this.

Suppose we use a two pulse sequence, the first one  $90^\circ$  and the second one, turned on a time  $\tau$  later, a  $180^\circ$  pulse. What happens? Figure 1.7 shows the pulse sequence and Figure 1.8 shows the progression of the magnetization in the rotating frame.

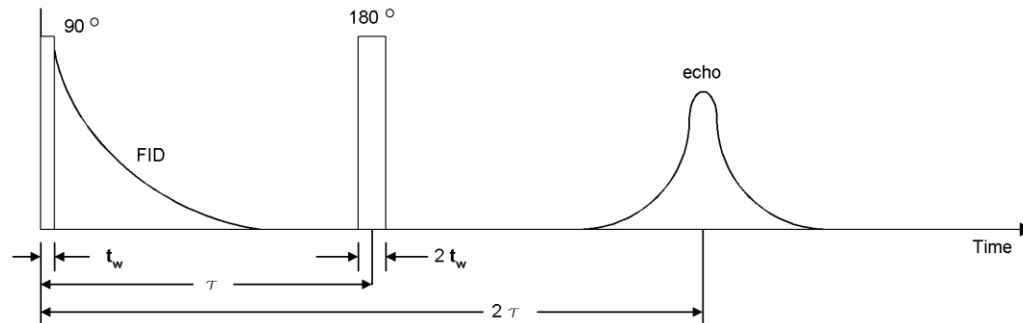

Figure 1.7: A  $90^\circ$  -  $180^\circ$  Pulse Sequence

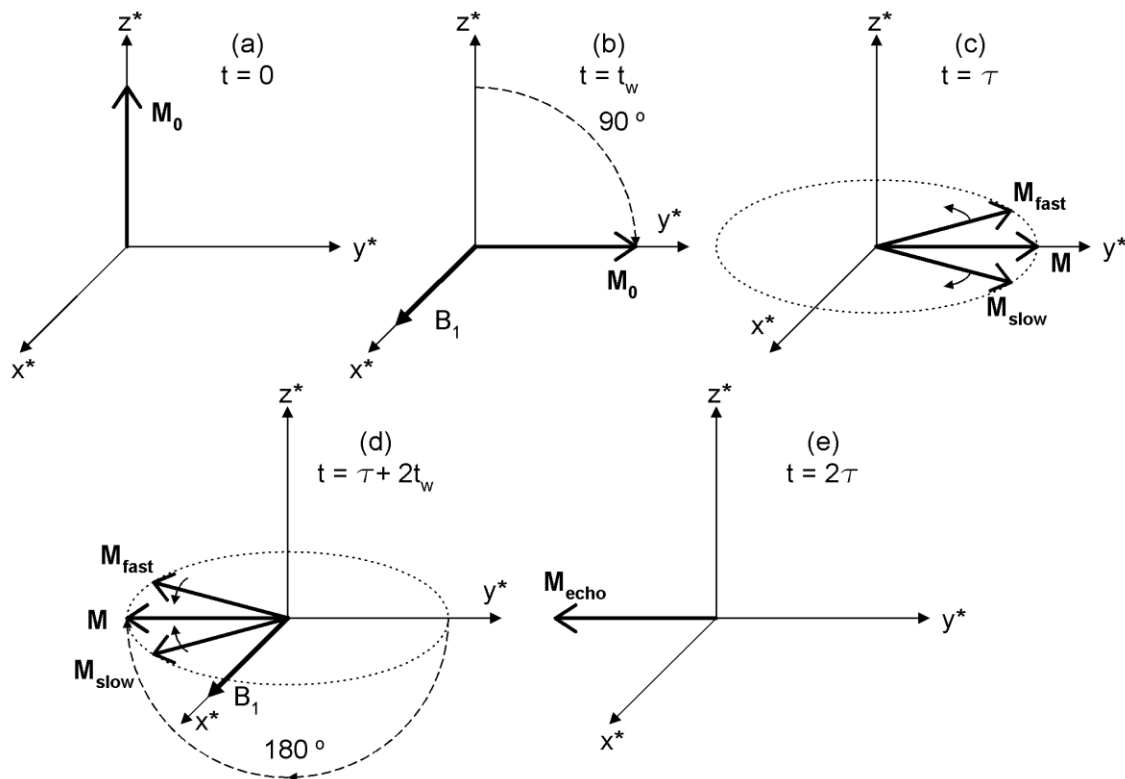

Figure 1.8: Progression of the Magnetization in the Rotating Frame

- Thermal equilibrium magnetization  $M_0$  along the  $z$  axis before the rf pulse.
- $M_0$  rotated to the  $y$ -axis after the  $90^\circ$  pulse.
- The magnetization in the  $x$ - $y$  plane is decreasing because some of the spins  $\Delta m_{\text{fast}}$  are in a higher field, and other spins  $\Delta m_{\text{slow}}$  are in a lower field static field.
- The spins are rotated  $180^\circ$  (visualize flipping the entire  $x$ - $y$  plane like a pancake on the griddle) by the pulsed rf magnetic field.
- The rephasing the three magnetization “bundles” to form an *echo* at  $t = 2t$ .

Study the diagrams in Figures 1.7 and 1.8 carefully. The  $180^\circ$  pulse allows the x-y magnetization to rephase to the value it would have had with a perfect magnet.

The echo process is analogous to an egalitarian and PC foot race for a kindergarten class, a race that makes all the children in the class winners, no matter how fast they can run. What if the race had the following rules? All the children are to line up at the starting line. At the first whistle, they are to run as fast as they can down the field. At the second whistle, they are to turn around and run back toward the starting line. First person back wins!! Of course, it is a tie, except for the ones who “interfere” with one another or fall down. As the children run away, the field spreads out with the fastest ones getting farther and farther ahead. At some point there is no semblance of order. On the trip back, as the faster ones overtake the slow pokes, who are now in the lead, the group comes together again “rephasing” as they pass the start line.

In Pulsed NMR, the  $180^\circ$  pulse is like that whistle. The spins in areas of larger field get out of phase by  $+\Delta\theta$  in a time  $\tau$ . After the  $180^\circ$  pulse, they continue to precess faster than  $M$  while the slower precessing spins do just the opposite. At  $2\tau$  all the spins return to the in-phase condition and then again dephase.

Yet some loss of  $M_{x,y}$  magnetization has occurred and the maximum height of the echo is not the same as the maximum height of the FID. This loss of transverse magnetization occurs because of stochastic fluctuation in the local fields at the nuclear sites which is not rephasable by the  $180^\circ$  pulse. These are the real  $T_2$  processes that we are interested in measuring. To find the “real”  $T_2$ , we use a series of  $90^\circ > \tau > 180^\circ$  pulse experiments, varying  $\tau$ , and then plotting the echo height as a function of time between the FID and the echo.

The transverse magnetization as measured by the maximum echo height is written as:

$$M_{xy}(2\tau) = M_0 e^{-\frac{2\tau}{T_2}} \quad (1.24)$$

That’s enough theory for now. **Let’s summarize:**

1. Magnetic resonance is observed in systems whose constituent particles have **both** a magnetic moment and angular momentum.
2. The resonant frequency of the system depends on the applied magnetic field in accordance with the relationship  $\omega_0 = \gamma B_0$  where

$$\gamma_{\text{proton}} = 2.675 \times 10^8 \text{ radian/sec-tesla}$$

or

$$f_{\text{proton}} = 42.58 \text{ MHz/tesla} \quad (\text{for protons})$$

$$f_{\text{fluorine}} = 40.055 \text{ MHz/tesla} \quad (\text{for fluorine})$$

3. The thermal equilibrium magnetization is parallel to the applied magnetic field, and approaches equilibrium following an exponential rise characterized by the constant  $T_1$  the spin-lattice relaxation time.

4. Classically, the magnetization (which is the vector sum of the individual magnetic moments of the nuclei) obeys the differential equation

$$\frac{d\mathbf{M}}{dt} = \gamma(\mathbf{M} \times \mathbf{B})$$

where  $\mathbf{B}$  may be a time dependent field.

5. Pulsed NMR employs a rotating radio frequency magnetic field described by

$$\mathbf{B}(t) = B_1 \cos \omega t \hat{i} + B_1 \sin \omega t \hat{j} + B_0 \hat{k}$$

6. The easiest way to analyze the motion of the magnetization during and after the rf pulsed magnetic field is to transform into a rotating coordinate system. If the system is rotating at an angular frequency  $\omega$  along the direction of the magnetic field, a fictitious magnetic field must be added to the real fields such that the total effective magnetic field in the rotating frame is:

$$\mathbf{B}_{\text{eff}}^* = B_1 \hat{i}^* + (B_0 - \frac{\omega}{\gamma}) \hat{k}^*$$

7. On resonance  $\omega = \omega_0 = \gamma B_0$  and  $\mathbf{B}_{\text{eff}}^* = B_1 \hat{i}^*$ . In the rotating frame, during the pulse, the spins precess around  $\mathbf{B}_1^*$ .
8. A  $90^\circ$  pulse is one where the pulse is left on just long enough ( $t_w$ ) for the equilibrium magnetization  $M_0$  to rotate to the x-y plane. That is;

$$\omega_1 t_w = \pi/2 \text{ radians} \quad \text{or} \quad t_w = \frac{\pi}{2\omega_1}$$

But

$$\omega_1 = \gamma B_1 \quad (\text{since, on resonance, } B_1 \text{ is the only field in the rotating frame.})$$

So,

$$t_w(90^\circ) = \frac{\pi}{2\gamma B_1} \quad \text{duration of the } 90^\circ \text{ pulse} \quad (1.25)$$

9.  $T_2$  - the spin-spin relaxation time - is the characteristic decay time for the nuclear magnetization in the x-y (or transverse) plane.
10. The spin-echo experiments allow the measurement of  $T_2$  in the presence of a nonuniform static magnetic field. For those cases where the free induction decay time constant, (sometimes written  $T_2^*$ ) is shorter than the real  $T_2$ , the decay of the echo envelope's maximum heights for various times  $\tau$ , gives the real  $T_2$ .

## C. REFERENCES

The following is a rather long list, and you certainly will not have the time all of them. In fact, you may only have time to read a rather small percentage of what is listed. But, you must take the time to read some of them so you have a basic understanding of magnetic resonance spectroscopy.

### C.1 Books

C.P. Slichter: "Principles of Magnetic Resonance" Springer Series in Solid-State Sciences 1  
Third Edition (1990) Springer-Verlag

A complete text with problems, clear explanations, appropriate for advanced undergraduate or graduate level students. **Any serious student of magnetic resonance should own it.** Everyone should read at least some of it. This reference contains a nearly complete bibliography of the important papers published in both NR and ESR spectroscopy. Consult this text for references to particular subjects.

T.C. Farrar, E.D. Becker: "Pulsed And Fourier Transform NMR", Academic Press 1971

A good introduction, with simplified mathematics, to the subject. Gives students a physical feel for the basic ideas of PNMR.

G. E. Pake and T. L. Estle: "The Physical Principles of Electron Paramagnetic Resonance",  
Benjamin-Cummings, Menlo Park CA (1978)

Don't let the title ESR scare you away from using this excellent text. It has clear discussions of important ideas of magnetic resonance, such as the rotating coordinate systems etc.

R. T. Schumacher: "Introduction to Magnetic Resonance", Benjamin-Cummings,  
Menlo Park CA 1970.

N. Bloembergen: "Nuclear. Magnetic Relaxation", W.A. Benjamin, New York 1961

This is Bloembergen's Ph.D. thesis, reprinted, but it is like no other thesis you will ever read. Describes some of the classic ideas of magnetic resonance, still very worth reading, you will see why he is a Nobel Laureate.

A. Abragam: "Principles of Nuclear Magnetism", Clarendon, Oxford 1961

This text is in a class by itself, but not easy for the beginner. Abragam has his own way of describing NMR. Important, but clearly for advanced students.

E. R. Andrew, "Nuclear Magnetic Resonance &' Cambridge University Press, New York, 1956

A good general discussion of theory, experimental methods, and applications of NMR.



- C. Kittel “Introduction to Solid State Physics” 5th edition, Wiley, New York 1976 in Chapter 16.  
A reasonable place to begin the subject of magnetic resonance, very brief, not fully worked out, but a good first overview;
- D. M. S. Bagguley editor: “Pulsed Magnetic Resonance: NMR, ESR, and Optics, a Recognition of E. L. Hahn, Clarendon Press, Oxford 1992.  
A wonderful collection of historical reminiscences and modern research applications of pulsed magnetic resonance. Useful for advanced students.

## C.2 Papers

- E. L. Hahn: “Spin echoes” Phys. Rev 80, 580-594 (1950)  
The first report on PMR and still a wonderful explanation, worth reading.
- H. Y. Carr, E. M. Purcell: Effects of diffusion on free precession in nuclear magnetic resonance experiments. Phys Rev 94, 630-638 (1954)  
Anything Ed Purcell signs his name to is worth reading! This certainly is one such example. A must for PMR.
- N. Bloembergen, E. M. Purcell, and R. B. Pound: “Relaxation effects in Nuclear Magnetic Resonance absorption,” Phys. Rev. 73, 679-712 (1948)  
A classic paper describing basic relaxation processes in NMR.
- S. Meiboom, D. Gill: Rev of Sci Instruments 29, 6881 (1958)  
The description of the phase shift technique that opened up multiple pulse techniques to measuring very long  $T_2$ 's in liquids.
- K. Symon, “Mechanics” 3d ed. Addison-Wesley, Reading, MA (1971)  
A good place to learn about rotating coordinate systems, if you don't already understand them.
- R. G. Beaver, E. L. Hahn, Scientific American 6, 251 (1984)  
A discussion of the echo phenomenon and mechanical memory.

## II. THE INSTRUMENT

### A. RECEIVER MODULE

#### A.1 Overview

The basic function of the receiver module is to amplify the small voltage induced in the sample coil by the precessing nuclear spin polarization to a large enough amplitude where it can be easily displayed on an oscilloscope. After passing through the input coupling circuitry, the signal from the sample coil is amplified by a fixed gain low noise amplifier (LNA) with approximately 20 dB of gain and noise figure of approximately 2.5 dB.

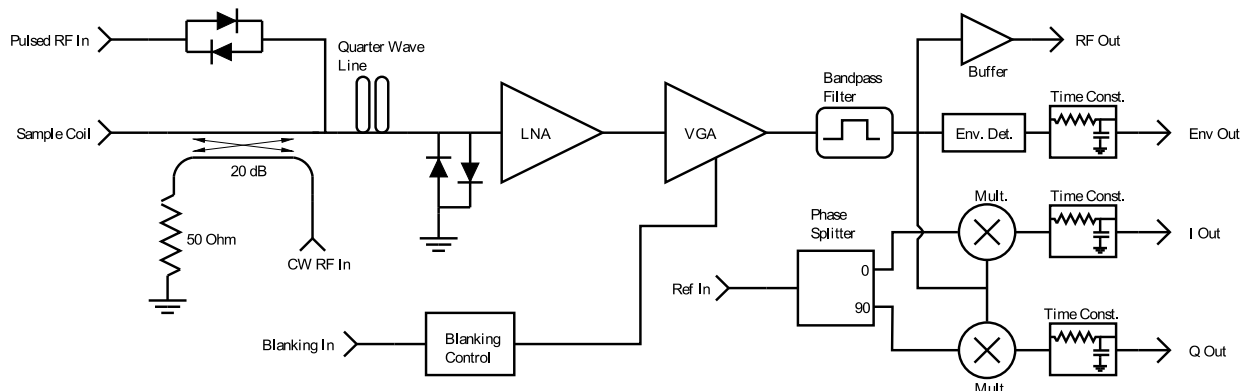

Figure 2.1

The output of the low noise amplifier is fed into a variable gain amplifier. The gain of this amplifier can be varied from 0 to 80 dB using the **Gain** control. Both of these two amplification stages are designed to have a wide enough bandwidth so that they can amplify the signals from both protons and fluorine nuclei, and have fast recovery times for pulsed NMR experiments. The output of the variable gain stage is then filtered by a narrow band filter to eliminate out-of-band noise. The center frequency of the narrow band filter can be switched between two values, corresponding to the proton and fluorine resonant frequencies, using the **Band** switch marked p and f (for proton and fluorine). A buffered version of the filter output is available at the **RF Out** connector.

The output of the filter is also sent to the inputs of the envelope detector and the phase sensitive detectors. The envelope detector tracks the amplitude of the input RF voltage and drives the **Env. Out** connector on the receiver module. The **I Out** signal from the phase sensitive detector is the product of the **Ref In** signal and the filter output, while the **Q Out** signal is a product of the **Ref In** signal shifted 90° and the filter output. By adjusting the phase of the **RF Out** signal from the Synthesizer module, you can make these signals correspond to the in-phase and quadrature components of the NMR signal. The outputs of all three detectors (**I Out**, **Env. Out**, and **Q Out**) are filtered by single pole RC filters (6dB/octave) as determined by the setting of the **TC** control on the receiver module panel.

The input section of the receiver module is designed for use in both continuous wave (CW) and pulsed experiments. It functions slightly differently in these two applications, so they are described separately. To start with we assume that the receiver coil is tuned so that it matches the 50 Ohm impedance of the coaxial cable connecting the sample coil to the **Sample Coil** connector on the receiver module. Chapter III, Sections C.1 and C.3 describe how the sample probe is tuned to satisfy this requirement.

## A.2 Pulsed Mode Operation

In pulsed mode operation, the pulsed RF output of the synthesizer module must be coupled to the sample coil to produce the  $B_1$  field that rotates the direction of the nuclear spin polarization. During the RF pulse, the input of the receiver must not interfere with the application of the RF pulse to the sample coil. Once the RF pulse is complete, the input of the receiver must be coupled to the sample coil so that it can amplify the induced RF signal, without interference from the Pulsed RF output of the synthesizer. Essentially, the sample coil should be connected to the synthesizer's Pulsed RF output and disconnected from the receiver during RF pulses. Between RF pulses, the opposite should be true; the sample coil should be connected to the receiver input and disconnected from the synthesizer's Pulsed RF output. See Figure 2. This entire changeover must take place in microseconds, so that signals with short  $T_2$  may be observed. This bit of magic is performed using non-linear devices called diodes and resonant transmission lines.

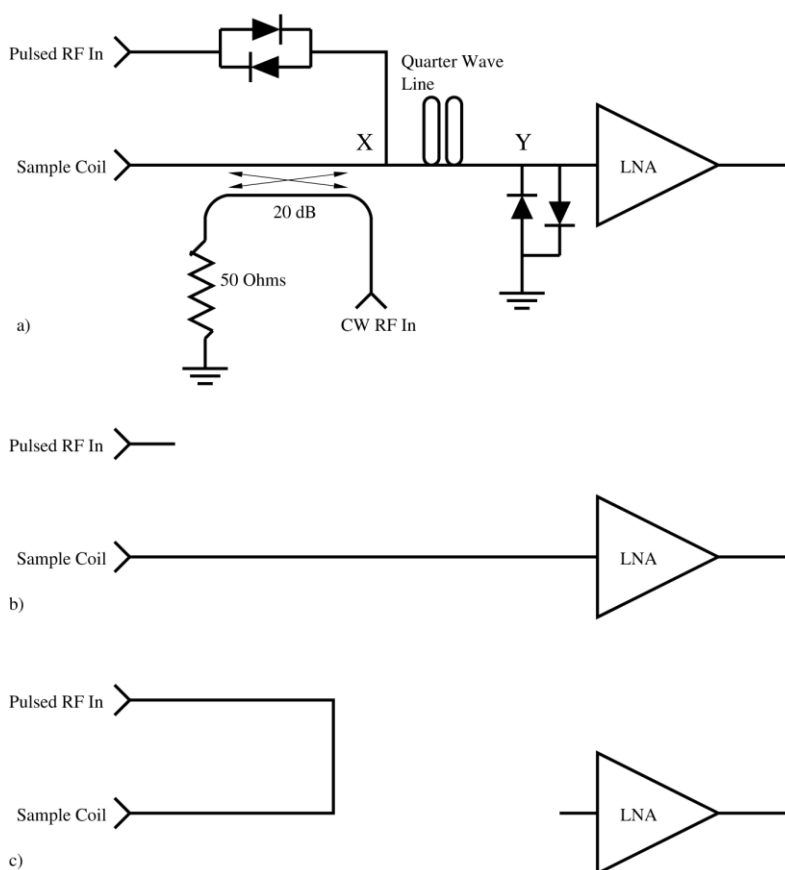
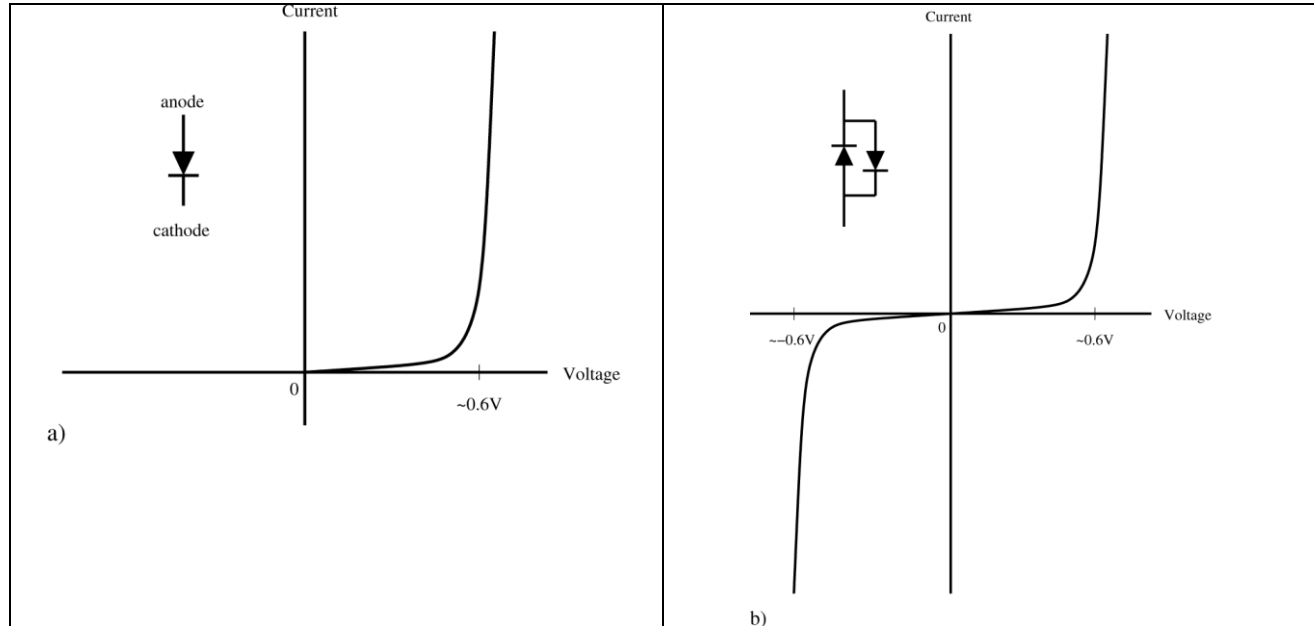

Figure 2.2 (a) PS2 input section circuit. (b) Receiver input section operation, RF pulse off. (c) Receiver input section, RF operation pulse on.

## A.2a Diodes in a Nutshell

For those of you unfamiliar with diodes, a diode is a two terminal device which has very non-linear current - voltage (I-V) characteristics. The diodes used in the receiver module are silicon p-n junctions, and have I-V characteristics as shown in Figure 2.3a.



Figures 2.3 (a) Single diode characteristics

(b) Back-to-back diode characteristics

The current through the diode  $I$ , may be roughly described as an exponential function of the voltage applied between the diode's two leads,  $V$

$$I = I_0 e^{\frac{V}{V_0}} \quad (2-1)$$

where  $V_0$  is about 0.6 V,  $I_0$  is a positive constant, and we take  $V$  as positive when the diode's anode is more positive than the cathode. For applied voltages much smaller than  $V_0$  very little current flows, so the diode can be treated as a high impedance, or open circuit. (Actually, the diode has a small amount of capacitance, so a slightly more accurate model would be that of a small capacitor.) Conversely, when applied voltages are large compared to  $V_0$ , very large currents flow, so the diode can be modeled as a low impedance, or short circuit. The above discussion works when  $V > 0$  (positive voltages). Note that very little current flows for any value of  $V < 0$ . The RF signals we are dealing with, however, are both positive and negative, so rather than using single diodes, they are used in 'back-to-back' pairs, as shown in Figure 2.3b. In this configuration, when  $|V| \ll V_0$  the pair of diodes may be treated as an open circuit, and when  $|V| > V_0$  they can be treated as a short circuit.

### A.2b Operation Pulsed Mode - Between Pulses

The operation of the input section of the receiver between pulses can now be understood. (See Figure 2.2a.) For this discussion we can ignore the presence of the directional coupler in the circuit. Between pulses, no signal is coming from the pulsed RF output of the synthesizer (by definition!), and the induced voltages in the sample coil produced by the precessing nuclear spin magnetization is very small (typically 10's of  $\mu\text{V}$ ) compared to  $V_0$ . In this case both back-to-back diode pairs act like open circuits, so the pulsed RF output of the synthesizer module is effectively disconnected from the sample coil, and the sample coil is connected to the receiver input amplifier through the  $\lambda/4$  length of coaxial cable in the receiver module. (See Figure 2.2b) The back-to-back diodes across the input of the receiver module have no effect on the very small signal entering the input of the receiver.

### A.2c Operation Pulsed Mode - During RF pulses

During an RF pulse the pulsed RF output of the synthesizer module swings about  $\pm 25 \text{ V}$ . The diodes connecting the pulsed RF output of the synthesizer to the sample coils may therefore be treated as short circuits (low impedance), so they directly connect the pulsed RF output to the sample coil as desired. (See Figure 2.2a) But wait... there seems to be a problem... the back-to-back diodes across the input of the low noise amplifier also seem to have a large voltage applied to them, and therefore can also be treated as short circuits. If these are in a low impedance state they would appear to be shorting the RF applied to the sample coil to ground through the  $\lambda/4$  coaxial line. In the low impedance state, the impedance of the diodes is much less than the  $50\Omega$  characteristic impedance of the  $\lambda/4$  line, so there is wave reflected from this end of the  $\lambda/4$  line  $180^\circ$  out of phase with the wave incident on the diodes. This reflected wave sets up a standing wave on the  $\lambda/4$  cable, with a node at the input to the low noise amplifier (point Y), and an antinode at the opposite end of the  $\lambda/4$  line (point X). Nodes in the voltage standing wave correspond to low impedance points, while antinodes correspond to high impedance points. Since the end of the  $\lambda/4$  cable where the RF pulse is being coupled (point X) from the synthesizer is an antinode, this point is a high impedance, and may therefore be treated as an open circuit! So the back-to-back diodes at the LNA inputs are not shorting the RF pulse to ground, since the  $\lambda/4$  length of cable transforms the low impedance at its one end to a high impedance at the other end. The RF pulse from the synthesizer is therefore applied to the sample coil (See Figure 2.2c.) as desired.

### A.2d Operation Pulsed Mode - Blanking

Even with the back-to-back diodes and  $\lambda/4$  cable, the voltage at the input of the LNA during an RF pulse is many orders of magnitude larger than the voltage induced in the sample coil by the precessing nuclear spin polarization. In order to insure a rapid recovery after the RF pulse ends, *blanking* has been incorporated into the receiver. The **Pulse Programmer** outputs a blanking signal which starts about 10 ns before the RF pulse begins and ends when the RF pulse is complete. The receiver uses this signal to reduce the gain of its RF amplifiers during the RF pulse to prevent the amplifiers from overloading, and to prevent the capacitors in the outputs of the detectors from being charged. The blanking circuitry has the ability to extend the blanking period past the end of the RF through use of the **Blanking Duration** control. This allows for optimizing the blanking interval to compensate for different sample coil tunings.

### A.3 CW Mode Operation

The key to understanding the input section of the receiver operating in the CW mode is to understand the operation of the directional coupler. When operating in CW mode the RF signals applied to the input of the receiver module are always small enough that the back-to-back diode pairs can always be treated as in the high impedance state.

#### A.3a Directional Couplers in a Nutshell

A directional coupler is a 4 port device that directs signals between its various ports depending on the direction of power flow. Figure 2.4a shows the symbol for a 20 dB directional coupler.

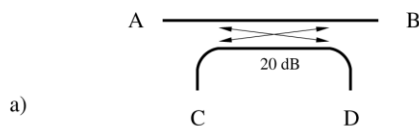

Figure 2.4a Symbol for a 20 dB directional coupler

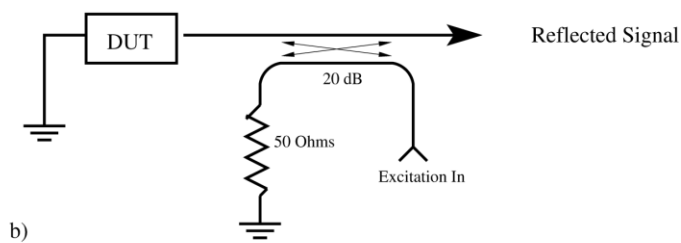

Figure 2.4b Simple reflectometer made from a directional coupler

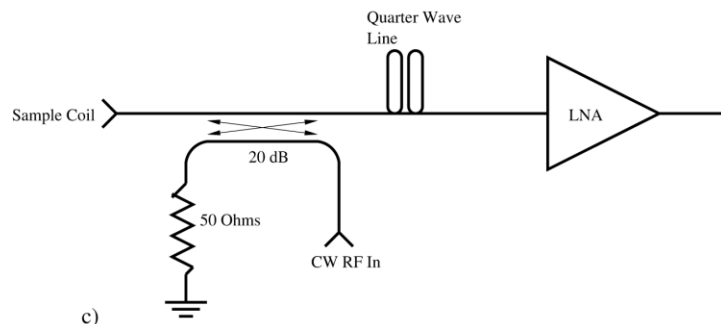

Figure 2.4c Receiver input section operating as a reflectometer

(We will assume an ideal lossless coupler for this discussion.) Directional couplers are designed for specific cable impedances, in the case of the PS2 system the reference impedance is  $50 \Omega$ . The 20 dB refers to the magnitude of the *power* coupling between the main and coupled ports. If we connect a signal source to port A of the coupler, 99% of the power will emerge from port B, 1% from port D and none from port C, the *isolated* port. Alternately, if we connect the signal source to port B, 99% of the power will emerge from port A, 1% from port C and port D will be isolated. If the signal is input to port C, 99% of the power is directed to port D and 1% to port B and port A is isolated. Finally, port C receives 99% of the power input to port D while port A gets 1% and port B is isolated.

Directional couplers are completely passive devices (they take no power to operate), and at radio frequencies are usually made from transformers. At first you may be a bit surprised by their operation, which may seem a bit like magic, but you shouldn't be. A partially silvered mirror placed diagonally in a light beam does the same thing! A word of caution - there are definite phase relationships present between the various signals described above - the amplitudes of the various waves must be summed with the appropriate phase factors when signals are input to multiple ports simultaneously. Finally, when you see a directional coupler drawn with only 1 directional port (as on the front panel of the PS2 receiver) this simply means that the unused port is terminated with a load of the characteristic impedance for which the coupler was designed.

### A.3b CW Mode Reflectance Bridge

It is easy to see how to construct a reflectance bridge using the simple characteristics described above. (See Figure 2.4c.) The component to be measured is connected to port A of the directional coupler, and the output signal is monitored at port B. An excitation signal is applied to port D of the coupler and port C is terminated with a  $50\ \Omega$  load. (This is the unused port which is not shown on the front of the PS2 receiver module). 99% of the excitation power emerges from port C and 1% from port A. Since port C is terminated at its characteristic impedance, all the power emerging from port C is absorbed, and none is reflected back into port C. The 1% of the excitation power emerging from port A travels to the sample to be measured. If the complex impedance of the component being measured (commonly referred to as the device under test, or DUT) is  $Z$ , the *amplitude* reflection coefficient will be

$$\frac{Z - Z_0}{Z + Z_0} \quad (2.1)$$

with a corresponding power reflection coefficient of

$$\left| \frac{Z - Z_0}{Z + Z_0} \right|^2 \quad (2.2)$$

Any reflected wave from the component being measured enters port A, and 99% of this power emerges from port B. This is the only power emerging from port B. (Port C is the only other port which couples to port B and, as previously described, no power is incident on this port since it is terminated with  $50\ \Omega$ .) Therefore, by monitoring the amplitude and phase of the signal emerging from port B the reflection coefficient of the component connected to port A may be measured.

In the PS2 receiver module, port A is connected to the **Sample Coil** connector, port B to the input of the LNA through the  $\lambda/4$  cable, and port D to the **CW In** connector. (See Figure 2.1 and 2.4c) For operation as a reflectometer the CW output of the synthesizer module is connected to the CW input of the receiver module to provide the RF excitation, and the sample coil is connected to the **Sample Coil** connector of the receiver module. The receiver's RF output therefore is an amplified version of the signal reflected from the sample coil. **It is best practice to remove the reverse gender BNC cable from the Pulsed RF input when operating in CW mode.**

The phase sensitive detector can be used to display the phase and amplitude of the signal reflected from the sample coil. To do this the **Ref. Out** of the synthesizer module is connected to the **Ref. In** connector of the receiver module providing a phase reference signal. The in-phase and quadrature outputs then represent the two orthogonal phases of the signal reflected from the sample coil. A good way to display these signals is to place your oscilloscope in X-Y mode with equal sensitivity settings (about 1V/div) for both the X and Y axis. Set the beam to be centered in the screen when the X and Y inputs are at zero volts. The vector from the center of the screen to the displayed beam position then represents the amplitude (distance from the screen center) and phase (angle from the screen center) of the reflected signal.

There is an unknown phase constant (rotation about the center of the screen) arising from propagation delays from both the cable connecting the sample coil to the receiver and the amplifiers and filters in the receiver module. Both the gain and phase of the reflectometer may be calibrated by replacing the sample coil with a component with a known reflection. The simplest component to use is a resistor with a value slightly different from the nominal 50  $\Omega$  impedance of the coaxial cables. The amplitude and phase of the reflected signal may be calculated using equation 2.1. By varying the phase of the **Ref. Out** signal from the synthesizer module (using the **Phase** menu item) you can rotate the display of the reflected signal on the oscilloscope so that the real component lies along the X-axis. A word of caution -- The reflectometer in the PS2 receiver will only operate accurately when the reflection coefficient of the component connected to the Sample Coil connector is relatively small. This limitation arises from the fact the the input of the LNA is not well matched to 50  $\Omega$ , so that a standing wave can be set up between the LNA input and the device being measured.

The standing wave is small and has little effect on the measurement when the reflection coefficient of the item being measured is small, but will result in significant errors when the reflection coefficient is large, such as when a short circuit or open ended cable are present. The reason is that the input of the LNA amplifier is not matched to 50  $\Omega$  arises from the matching requirements needed to achieve low noise operation. In general the impedance matching requirements needed to achieve low noise operation are different from those needed to achieve a low reflectivity input match to the amplifier.

## B. 21 MHz SYNTHESIZER

### B.1 Overview

The synthesizer module is the source of the radio frequency (RF) signals used in the spectrometer. It is a modern, digitally synthesized, high stability, signal source with a wide frequency range. This unit can produce RF signals from below 1 MHz to over 30 MHz, but that is a much larger range than is needed for the operation of the NMR spectrometer. The proton and fluorine precession frequencies are only 6% different, but the field of the permanent magnet varies from unit-to-unit by several percent and will also drift with ambient temperature. Your unit has the proton's precession frequency in your magnet, at ambient room temperature, marked on the serial label. The marked frequency is a good place to start your "tuning up" of the spectrometer.



The unit has six (6) BNC connectors, three inputs and three outputs. The function of each of these connectors is described below.

1. REF Out: This refers to “reference” output signal that is connected to the **REF. In** on the receiver module. It provides a continuous wave, sinusoidal signal (CW) to the phase sensitive detectors in the receiver. The phase of this signal, relative to the phase of the Pulsed RF Out signal can be adjusted, quasi-continuously (in one degree steps) by the selector knob using P in the menu. This signal can be switched off by the toggle above the BNC connector
2. CW Out: This is a continuous wave sinusoidal signal that is used for CW resonance detection. This signal is fed into the RF probe via the directional coupler inside the receiver module. Its amplitude can be adjusted in this module when the menu is set on A. The power is measured in dBm and can be varied in one dB steps. **This output must be connected to the CW In on the Receiver but the BNC cable must be removed when operating in the pulse mode.** The CW output can be turned off by the toggle above the connector.
3. Pulsed RF Out: This is the high power pulsed RF signal that is sent to the coil surrounding the sample via the receiver module. This is a reverse “gender” BNC connector which requires the reverse gender BNC cable to connect it to the RF Pulse In on the receiver module. The cables have “female” BNC connectors, and the BNC panel connectors are male. It is essential that the correct BNC cable is used. The usual BNC male cable connector will not work and should not be forced on.
4. Pulse In, I and Q: These are both inputs connected to the respective I and Q Pulse Out on the Pulse Programmer module. They receive the timing pulses that shape the RF output power used to “tip” the nuclear spins.
5. Sweep In.: This may be used to sweep the RF frequency with an external analog voltage. It may be used in observing CW NMR resonance. It should not be connected in pulse mode operation.

## B.2 Specifications

Frequency: 1 – 30 MHz

Frequency Stability:  $\pm 50$  ppm

Frequency Increments: steps of 100 KHz, 1 KHz, 10 Hz

Phase:  $-180^\circ$  to  $+180^\circ$  in one degree steps

CW Amplitude: -10 dBm to -65 dBm in 1 dB steps

Sweep: 0, 1, 2, 5, 10, 20, KHz/Volt

## C. PULSE PROGRAMMER

### C.1 Overview

As its title implies, this is the module that produces timed pulse sequences used in the various pulsed NMR experiments. This unit sets the pulse lengths for what are called the A and B pulses. In pulse mode, this unit cannot change the amplitude of the RF pulse, we must adjust the **pulse length** to achieve a 90° of 180° rotation of the magnetization – the so-called “ninety or one hundred eighty degree” pulse.

There is only one A pulse in any pulse sequence. There can be as few as zero and as many as 100 B pulses. The number of B pulses appears on the menu as N, Num\_B:. The length of the A pulse appears on the menu as A; A\_Len: and the length of the B pulse as A B\_len:. Both pulse lengths can be varied from 0.02  $\mu\text{s}$  to 20.02  $\mu\text{s}$ . Appearing on the menu as tau:, the time,  $\tau$ , between the A and B pulse can be varied from 0.0001 s to 9.999 s. The repetition time, written on the menu as P, Period: is the time delay between repeats of the **entire pulse sequence**, meaning the complete pattern of the single A pulse and the chosen number of B pulses. The repetition time can range from 0.2 milliseconds to as long as 100 seconds. If a longer repetition time is required, the Man Start button can be used as a manual start of the pulse sequence. Set the menu to Period: manual to use this feature.

The module provides a short ( $\sim 1 \mu\text{s}$ ) trigger pulse to trigger a ‘scope or a computer on either the A or the B pulse. The choice of pulse is made with the toggle marked Sync. Toggle switches are provided on both the A and B pulses to allow either pulse to be turned off as desired. The toggle marked MG is used to disable the Meibohm-Gill 90° phase shift between the A and B pulse in a pulse train that measures  $T_2$  with multiple B pulses. The Blanking Out pulse is a pulse slightly longer than A and B which disables the receiver during the pulse and thus prevents internal capacitors from charging during the RF pulse. This facilitates a faster recovery of the receiver.

Finally, the Ext Start-input requires a TTL pulse which will start a pulse string of the one A pulse and the programmed number of B pulses instead of the internal repetition cycle. Thus, the pulse sequence can be synchronized with any data collecting instrument that the user chooses.

### C.2 Specifications

1. A – A Pulse(one only) A\_len: 0.02 – 20.02  $\mu\text{s}$
2. B – B Pulse (0-100\_ B\_len: 0.02 – 20.02  $\mu\text{s}$
3.  $\tau$  tau: 0.0001 – 9.999 seconds
4. N Num\_B 0 – 100
5. P Period: 0.2 ms to 100 s
6. External Start TTL Pulse 4 volts 1  $\mu\text{s}$
7. Manual Start Button
8. Sync on either A or B pulse
9. Sync Out – 0.5  $\mu\text{s}$  TTL Pulse

## D. LOCK-IN, SWEEP MODULE

### D.1 Overview

The lock-in sweep module is used for continuous wave (CW) experiments. It is comprised of a two channel lock-in amplifier and a sweep ramp generator with a current output amplifier. Depending on the operating mode, one or both of these components may be in use simultaneously. The following sections describe the operation of this module.

### D.2 The Lock-In Amplifier

The lock-in amplifier contains an internal reference oscillator operating at a fixed frequency of 20 Hz, and two identical signal channels. During normal operation, the reference oscillator is coupled to the input of the current output amplifier to provide magnetic field modulation, and is simultaneously used to demodulate the signals applied to the lock-in inputs. The output of the demodulator is filtered by a simple RC time constant, and the resultant signal is output as both an analog voltage at the front panel connectors, and a digitized value via a Universal Serial Bus (USB) output port. Both lock-in channels operate with the same signal gain, demodulation phase and time constant settings, each of which can be adjusted by the user.

### D.3 Lock-In Related Menu Items

#### D.3a G – Gain

The gain of the lock-in amplifier can be varied from  $80 \text{ V/V}_{\text{rms}}$  to  $2560 \text{ V/V}_{\text{rms}}$  in factors of 2 by selecting the **G** menu item. The gain settings are calibrated in terms of rms input voltages, so an input signal of  $0.0125 \text{ V}_{\text{rms}}$  with a lock-in gain setting of  $80 \text{ V/V}_{\text{rms}}$  will produce a 1 volt output when the relative phase between the input signal and the lock-in reference phase is zero. If the input signal is too large for the gain setting, causing an overload condition, the **Input Overload** indicator on the front panel will illuminate. When this occurs, either the lock-in amplifier gain, or the amplitude of the input signal must be reduced to insure proper lock-in amplifier operation.

#### D.3b P – Phase

The phase of the lock-in demodulation is varied through use of the **P** menu item. Both lock-in channels operate with the same demodulation phase, which may be varied in  $1^\circ$  steps. While adjusting the phase, the upper line of the module's display switches to display the output voltages of the two lock-in amplifier outputs. Once the phase has been set to the desired value, pressing the Master Selector knob will return the cursor to the upper display line and the item menu will be displayed.

#### D.3c T - Time Constant

The output of the lock-in amplifier is filtered by a single RC time constant (6 dB/octave). The value of the time constant can be varied from 0.5 - 10.0 seconds using the **T** menu item. The value of the time constant also determines the rate at which the digitized outputs of the lock-in amplifier are output to the USB port for sweep modes **Off**, **Automatic**, **Triggered**, **Manual**, and **External**. In these modes the lock-in output signals are sampled and transmitted over the USB port twice per time constant period.

### D.3c M - Modulation

The amplitude of the magnetic field modulation is set using the **M** menu item. It can be disabled, or varied from 0.03125 to 4.0 mA rms in factors of 2. While the modulation level is being adjusted, the upper line of the display will switch to display the output voltages of the two lock-in amplifier outputs. Once the modulation level has been set to the desired value, pressing the Master Selector knob will return the cursor to the upper display line and the item menu will be displayed.

## D.4 Sweep Related Menu Items

### D.4a H - Field Offset

The **H** menu item is used to add a constant magnetic field offset to the sample in the probe head. This current can be varied from -250 mA to + 250 mA in 1 mA steps. The setting out the field offset is *not* reflected in the **Sweep I/O** output signal, so it can be used to center the observed signal within the magnet fields sweep range. While the field offset is being adjusted, the upper line of the display will switch to display the lock-in output signals. Once the field offset has been adjusted to the desired value, pressing the Master Selector knob will return the cursor to the upper display line and the item menu will be displayed.

### D.4b S - Sweep Mode

- OFF - Sweep generation is disabled. Only current corresponding to a field offset and modulation settings are applied sweep/modulation coils.
- Auto - In **Auto** mode the field sweep run continuously. The sweep extends from  $-I_{\max}$  to  $+I_{\max}$ , where is the value selected in the **Sweep Amplitude** menu item. The duration of the sweep is determined by the value selected in the **Sweep Duration** menu item. Sweeps are linear ramps with a rapid fly back. At the beginning of each sweep a 2.5  $\mu$ s, 5 V pulse is output from the **Trig I/O** connector. A voltage is also output from the **Sweep I/O** connector spanning -10 V to + 10 V corresponding to the entire sweep range.
- Triggered - The triggered mode is similar to the Auto mode, except the sweep does not commence until triggered, either by a rising logic edge on the Sweep Sync I/O connector or pressing the **Manual Start** button of the front panel. If a sweep is already in progress trigger inputs are ignored. The **Sweep I/O** output signal is the same as in **Auto** mode.
- External - In external mode the **Sweep I/O** connector is an input. The input range spans - 10 V to +10 V corresponding to a current range of -250 mA to + 250 mA. This is a fixed range and is *not* controlled by the **Sweep Amplitude** setting. **The Field Offset** and **Modulation** signals operate normally and are summed with the external input.
- Manual - Manual mode allows the value of the field sweep to be adjusted using the Master Selector knob on the lock-in front panel. After selecting this mode by pressing the Master Selector knob, the lower display line indicates the sweep value as a percentage of full scale, adjustable in 1% steps from -100% to + 100%, while the upper display line displays the lock-in outputs. The scale of the sweep is determined by the value selected in the Sweep Amplitude menu. The value of the **Sweep I/O** output varies from -10 V to + 10 V, corresponding to the entire sweep range. Pressing the Master Selector knob will return the user to the top menu.
- Rapid Scan (RSxx) - The **Rapid Scan** modes are used when observing the output of the receiver directly without lock-in demodulation. In this mode lock-in functions, including the

field modulation are disabled. The field repetitively sweeps in a triangle waveform with peak amplitude as selected by the **Sweep Amplitude** menu item. The frequency of the Rapid Scan sweep can be set to 1, 2, 5, 10, 20, 50 or 100 Hz. The **Sweep I/O** output varies from -10 V to +10 V, corresponding to the entire sweep range, with a sync trigger of 50  $\mu$ s, 5 V output at the Trig I/O connector.

#### D.4c A - Sweep Amplitude

The sweep amplitude menu item selects the amplitude of the sweep range for the **Auto**, **Triggered**, **Manual** and **Rapid Scan** modes. Sweep ranges of  $\pm 1.953$ ,  $\pm 3.906$ ,  $\pm 7.812$ ,  $\pm 15.625$ ,  $\pm 31.25$ ,  $\pm 62.5$ ,  $\pm 125$ , and  $\pm 250$  mA are supported.

#### D.4d D - Sweep Duration

The sweep duration menu item selects the duration of the field sweep for the Auto and Triggered modes. Sweep durations of 10, 20, 50, 100, 200 and 500 seconds are allowed.

## E. THE PERMANENT MAGNET

### E.1 Overview

The PS2-A spectrometer comes with a uniquely designed permanent magnet described in this section. The physical specifications of the magnet are as follows:

Field Strength in Gap:  $0.50 \pm .01$  Tesla  
 Homogeneity (minimum): 0.5 mT over  $0.125 \text{ cm}^3$   
 Gap Width: 1.78 cm  
 Pole Diameter: 10.1 cm  
 Permanent Magnet Material: NdFeB  
 Weight: 15 kg



Figure 2.5 The Permanent Magnet

Removing the wooden top and insulation exposes the basic “H” – frame geometry of the magnet assembly. Soft iron is used for the frame members and the NdFeB permanently magnetized disks are mounted on each side behind the pole tips. Neodymium-Iron-Boron material was selected as the permanent magnet because of its large magnetization and its ability to retain that magnetization. Simply put, the magnet will likely outlast the electronics, the professors, and even the students.

However, NdFeB has one characteristic that can be a problem. Its magnetization is temperature dependent. Thus, the field in the air gap depends on the temperature of the magnetic material. For many experiments, this drifting magnetic field will cause only a small error in the data. For other experiments, the drift is intolerable. In order to provide a wide range of experimental possibilities, TeachSpin designed a complete temperature control system that is easy to use and will regulate the temperature of the NdFeB magnets. The temperature of the magnetic material is kept so stable that the field in the gap remains essentially constant. Within 50 minutes after the regulation loop has been closed, the gap field will reach an impressive stability.

Field Stability:  $\pm 5 \times 10^{-4}$  mT over 15 minutes

(In frequency units, for proton resonance, the stability is  $\pm 20$  Hz.)

This, or even better, field stability is obtained if and only if the magnet is used in a reasonable laboratory environment.

The following is a list of “Do’s and Don’ts” that must be respected for the optimum performance of this high stability-high homogeneity magnet.

Do:

1. Place the magnet in a reasonably temperature stable location.
2. Place the magnet on a non-ferromagnetic table.
3. Check all electrical connections to the magnet, temperature controller and spectrometer main frame carefully before attempting any experiment.

**DO NOT:**

1. Place the magnet in a draft or near an open window.
2. Place the magnet near a vent or a radiator heater.
3. Place the magnet near AC high power lines.
4. Place the magnet near a power transformer – particularly the transformer at the right rear of the main frame of the spectrometer. (There is a reason why we always show the instrument with the magnet to the left of the controller!)
5. Place anything under the magnet that might obstruct the flow of air to the thermoelectric heat sinks.
6. Direct a strong light onto the magnet, especially light from an incandescent source.
7. Keep any significant ferromagnetic materials nearby such as a screw driver, a student belt buckle, steel chain . . . Be particularly careful with items that can move.
8. Move the magnet to a new location during or close to the time of starting an experiment, especially if you want to retain the maximum field stability.
9. Place your hand or other objects on the exposed heat sinks of the thermoelectric coolers.
10. Drop the magnet or give it a large mechanical shock
11. Let ferromagnetic “stuff” fall into the magnet gap - paper clips, pins, small tools, etc

12. **DO NOT** leave the thermal servo loops on overnight – or on for several days. This will not damage the magnet or the servo electronics, but it may mean that the system will be keeping the magnet at a temperature very far from the current ambient temperature of its surroundings. Part of what makes the PS2-A system so effective at keeping the temperature stable is that the magnet temperature is being locked to the temperature of the local environment at the time the loop was closed. Using a magnet with a servo that has been on too long is not an optimum starting condition for a set of experiments that require maximum field stability.

## E.2 Controlling the Temperature



Figure 2.6 Control Panel

The temperature of the NdFeB magnets on the two pole pieces are controlled by two identical and independent thermal servo units, one for each pole. These servo units are designed to keep the temperature of the individual magnetic disc on each pole at a constant temperature. Note that the specific temperature of an individual pole piece is not important. What is essential is that the temperature of each NdFeB disc remains constant for the duration of the experiment.

To accomplish this stability, a special thermistor temperature sensor is put in good thermal contact with each NdFeB disc. A thermistor is a special material whose resistance varies in a predictable and reproducible way with temperature. Thus, the value of the thermistor resistance is a measure of the temperature of the NdFeB disc, which is also a measure of its magnetization. The temperature of the disc is then modulated (controlled) by a thermoelectric cooler, which has the remarkable property of either cooling or heating a surface depending on the polarity of the current through it. Heat is transferred from the NdFeB magnetic to the heat sinks which exchange heat to the room by both convection and radiation. These heat sinks also masquerade as the side panel labels of the unit. Students should not put their hands on these heat sinks during critical runs where optimum temperature stability is required. Some care should be taken with these panels. Letting heavy objects hit them could damage the thermoelectric cooler.

Operating the servo loop temperature controller is straight forward. The last student who used the unit should have left the loop OPEN! This is easily done with the two toggle switches on the front panel. It can also be accomplished by turning the power off, using the power switch on the power entry module at the rear of the Mainframe. Using the power switch, however, is not the best practice because it will also turn off the electric field shim gradient coils. If you are using the shim coils for the experiment, they should have been left ON. The shim coils can be left on indefinitely without damage to either the coils or controller. Keeping the fields of the shim coils on requires that the

spectrometer also be left on. However, we recommend that both the A and B pulses on the pulse programmer be turned off.

Gradient coils ON and loop OPEN is the best way to leave the apparatus during a semester, where it is important to obtain optimum field stability in the shortest time. In this configuration, the magnet comes to steady state equilibrium in the shortest time with its ambient temperature.

The objective is now to lock the temperature of each magnetic disc at its existing temperature – or as near to it as is possible. Since each magnet might be at a slightly different temperature, or, more likely, since the temperature sensing thermistors are not exactly matched, it is essential to find the temperature set point for each side. With the loop OPEN, adjust both set point potentiometers on the front panel until the corresponding LED becomes dark. Red means the set point is too high, blue that it is too low. At the correct value, the LED goes dark. Figure 2.7 is a simplified block diagram of the controller which shows how this works. The thermistor is in one arm of a Wheatstone bridge and the output of the bridge is compared to the adjustable reference voltage. The difference is amplified by the instrument amplifier. Both the actual bridge signal from the thermistor and the reference voltage are available on BNC connectors on the back panel. You may monitor the thermistor bridge signal to assure yourself that the loop is stabilizing the temperature of the magnets.

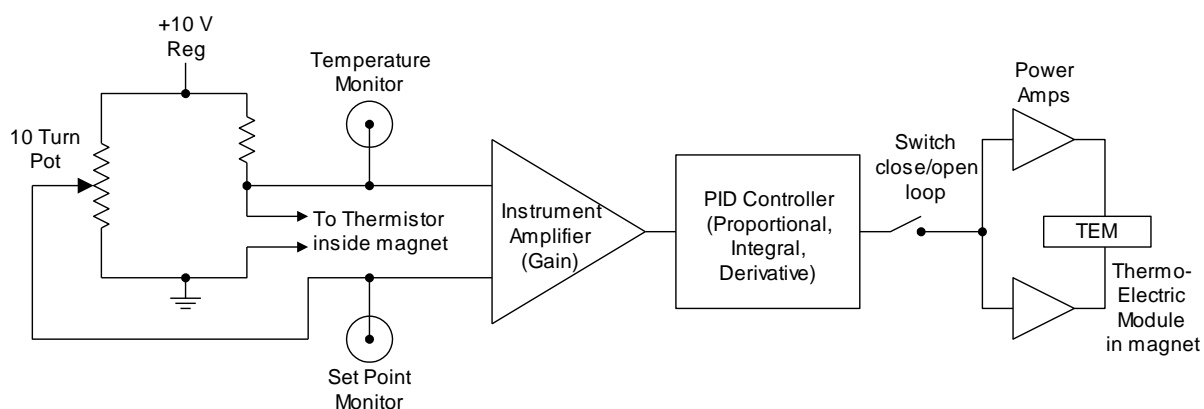

Figure 2.7 Simplified Block Diagram of the Controller

Once the two reference voltages have been carefully set and locked on the ten turn knobs, both loops should be closed simultaneously. You will likely notice some oscillation in the current to the TEC's but this should settle down in a minute or so as the loop PID (Proportions, integral, differential) establishes a fixed temperature. The LED should remain dark as long as the servo is doing its job and keeping the magnets at a fixed temperature. Also the temperature monitor voltage should remain constant and the same as the reference voltage. If this does not occur, repeat the starting procedure. If this system still does not lock the temperature, there may be loose cables or the system may need repair.

Because of the rather slow thermal response times for the entire magnet assembly, it takes about 45 minutes for the magnetic field to achieve optimum stability. Each magnet is slightly different and students may wish to measure this characteristic time as well as the stability of the one they are using. After making sure the field is homogenized and the gradient coils optimized (this can easily be done using a single pulse FID signal with a mineral oil sample), drifts in the magnetic field of as little as 10 Hz can be detected. This drift can be monitored using a two channel scope to compare the envelope output with the output of either of the phase sensitive detectors. (The phase and gain must be adjusted so that the two signals are equal.)



The controller can be operated for an indefinite time as long as the ambient temperature of the room is stable to about  $\pm 1$  C. Once the experiments are complete, the thermal loops on both of the magnetic loops should be switched to OPEN to allow the magnetic to establish equilibrium with the current room temperature. The field gradient coils should be left ON.

## F. MAGNETIC FIELD GRADIENT COILS

The magnetic field homogeneity over the sample volume can be significantly enhanced by using a set of four coils that form the sides of the RF probe unit. These coils are designed to produce magnetic field **gradients** in the region around the sample when steady dc current is passed through them. There are four sets of coils producing linear field gradients in the x, y, and z directions and a quadratic field gradient in the z direction. (See Figure 2.8 for the definition of the x,y,z axes.)

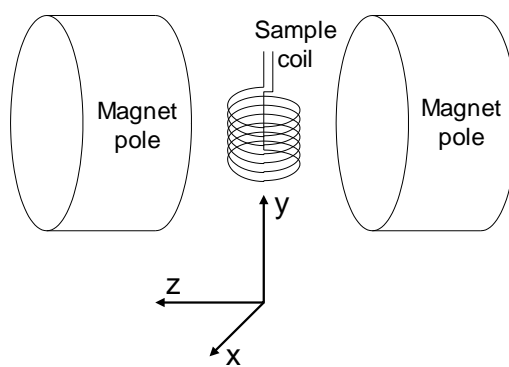

Figure 2.8 Simplified drawing of Magnetic Poles and Sample Coil showing x, y, and z axes.

Each gradient coil has two windings, one on each side of the RF probe. The coils are made on electronic circuit boards by electrochemical etching, and are therefore extremely dimensionally stable. Each is connected to a constant current regulated supply whose current is adjusted by a 10 turn potentiometer. The potentiometer shafts can be locked on the dial counter after adjustment. Current regulated supplies are used so that the current, which creates the field gradient, will not change as the resistance of the coils and leads changes with temperature.

For optimum field homogeneity, the field gradient coils should be adjusted by the students for each experiment. The gradients in the magnet may drift slightly with time and temperature, so the adjustment should be made before any critical experiment is performed. Please note that many experiments do not require optimum field homogeneity.

One can adjust the gradients with almost any liquid sample containing protons that has a “reasonable”  $T_1$  and a  $T_2 > 30$  msec. By reasonable we mean 30 – 100 msec, so that the repetition time can be 0.2 to 1.0 sec. Although ordinary water has a  $T_2 \gg 30$  msec, the long repetition time required (since  $T_1 \sim 2$  s) makes the experiment time consuming and cumbersome. Most light mineral oil samples will serve this purpose.  $T_2$  can easily be estimated using a two-pulse sequence and observing the spin-echo.

Optimization of the field gradients is achieved by systematically adjusting one gradient field after another while observing the Free Induction Decay (FID) envelope after a single 90° pulse - the longer the envelope, the more homogeneous the field. As good as they are, the gradient coils are not perfect. When the current is changed in the y-gradient coil, it may have some small effect on both the x and z linear gradients and may even produce a small effect on the value of the total field. Thus, one must go through the entire process several times to achieve the optimization of the field homogeneity. It is essential to optimize the field on a proton signal where the chemical shifts are small, and then use that homogenized field to observe the inequivalent fluorines in various fluorine samples.

Students should be able to obtain 5 ms  $T_2^*$  for the proton signal in light mineral oil. It may take some “fiddling around” to achieve this. Gradients can be added in either direction simply by flipping the reversing switch on the front panel. The currents in each coil can be monitored at the BNC connection under each control potentiometer. This point monitors the voltage across a 2.5  $\Omega$  precision resistor in series with the X and Y gradient coil, and a 1.25  $\Omega$  resistor for the Z and  $Z^2$  gradient coils. These monitor points can be used to record the currents and to determine their stability as well as to trouble shoot any problems that might occur in the electronics.

Specifications:

$$\frac{\partial B_z}{\partial z} = 6.6 (\mu T / mm) / amp$$

$$\frac{\partial^2 B_z}{\partial z^2} = 20 (\mu T / mm^2) / amp$$

$$\frac{\partial B_z}{\partial x}, \frac{\partial B_z}{\partial y} = 7.1 (\mu T / mm) / amp$$

## G. MAGNET YOKE ADJUSTMENT

The adjustment about to be explained should only be made by the faculty or staff in charge of this apparatus. ***Students should not attempt this adjustment!***

The magnet pole pieces are adjusted at the factory to reduce or nearly eliminate the X, Y linear gradients over the sample. After you have optimized the magnetic field homogeneity over the sample by adjusting the electric current gradient coils, you should notice that the X and Y linear gradient current settings are at only a small fraction of their entire range. But suppose, after many years, or after the magnet has been moved several times, students discover that they could improve the homogeneity of the field even more, but they have “run out of current” in say the Y-linear gradient. If indeed this is correct, realigning the pole pieces will greatly reduce the inherent Y-gradient of the magnet. (Please Note - This realignment of the pole pieces will primarily affect X and Y gradients and has only a very small effect on the Z-gradients).

The procedure is as follows: Place a small (few drops) light mineral oil sample in the RF sample probe. Be sure it is in the proper location. Tune the spectrometer for an FID following a single 90° pulse. Turn down the gradient coil currents to zero. ***Insert the 3/32” hex wrench with T-handle, into one of the three 1/8” holes in the front heat sink and engage one of the three set screws.\**** These set screws (which were initially adjusted at the factory) press on the front pole face and are used to align the front pole face to be parallel to the rear pole face. It is the “parallelness” of the two pole pieces that determines the X and Y linear gradients.

\* **Version A** does not have surface access to these set screws. Please call for adjustment procedure.

With the FID from the light mineral oil presented on an oscilloscope, adjust each of the three set screws to achieve the longest  $T_2^*$  (decay time). Usually, this takes many iterations, because moving one screw changes the effect of the others. You should only need to turn the screws a fraction of a rotation. If you go more than a full rotation, back off all the screws and start again.

When you have achieved the longest possible  $T_2^*$ , turn on the electric shim coils and use them to optimize the field gradients. If you have made the adjustment correctly, you should only need a small fraction of the available X and Y linear gradient currents to get to a maximum  $T_2^*$ .

Once these adjustments have been made, they should not need to be repeated for at least 6 months, maybe many years. This is certainly not an adjustment that should be needed every lab period. In fact, it is highly possible that you will never need it!

(Users of PS2-A please call for instructions.)

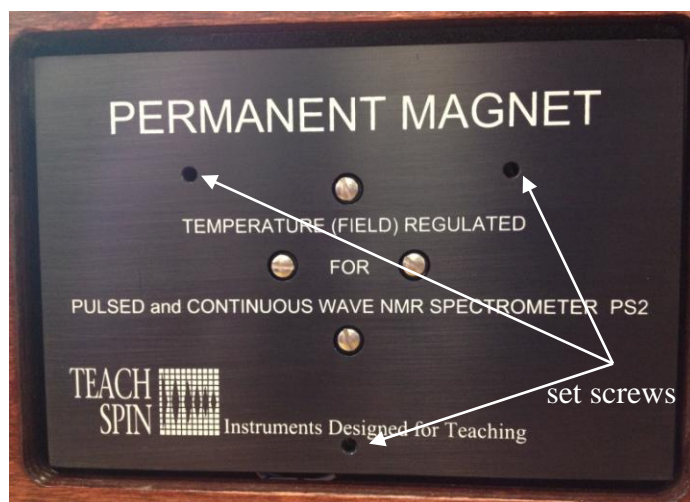

Panel Showing Access Holes for Set Screws

## H. MODULATION COILS

Along with the field gradient coils, a pair of Helmholtz-like coils is imbedded in the circuit boards that provide the sides to the RF probe of the spectrometer. These coils provide uniform magnetic fields in the z-direction – the direction of the main magnetic field. These coils are principally used in CW (Continuous Wave) NMR experiments. They provide a slow time-dependent sweep field as well as an AC modulating field.

The currents in the modulation coils come directly from the lock-in module on the main frame of the unit. All the controls for this unit come from the lock-in module. The electrical connection to the lock-in comes through the power cable connected from the rear of the main-frame to the back of the temperature/gradient controller unit.

The modulation coil can also be used to shift the DC field electronically. **However, along with this shift will come a change in the field homogeneity over the sample.** Care must be exercised by the user if the optimum homogeneity is to be maintained over the sweep.

Specifications:

Coil Constant: 3.1 mT/amp or 31 gauss/amp

Homogeneity: 1 part in 250

Resistance: 2  $\Omega$

## I. RF SAMPLE PROBE HEAD

### I.1 Overview

The single coil RF sample probe is shown in Figure 2.9, without the RF shield and the modulation and gradient coils which form the side walls. A top view is shown in Figure 2.9b. The circuit diagram is shown in Figure 2.10.

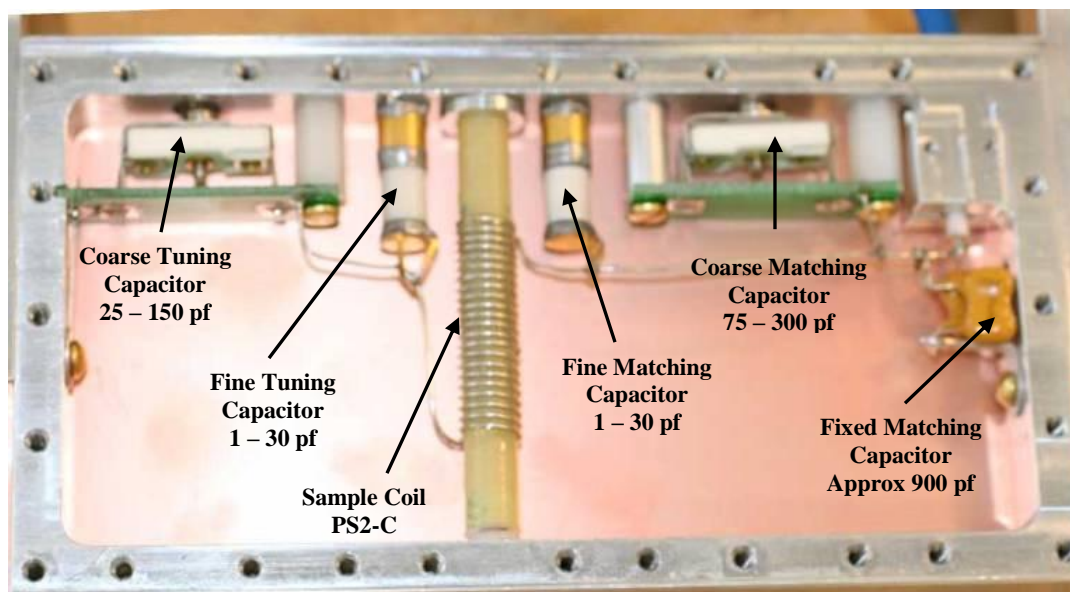

Figure 2.9a RF Sample Probe PS2C (RF Shield and Modulation and Gradient Coils not Shown)  
NOTE: Short Sample Coil of PS2A/B must be replaced for 1-D Imaging)

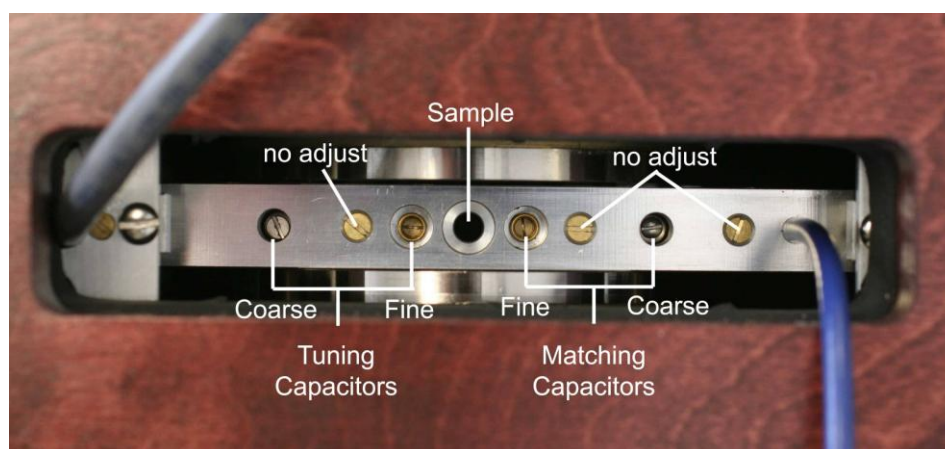

Figure 2.9b RF Sample Probe Seen from above

The two capacitors on the left side combine to tune the sample coil into series resonance at the frequency of the applied RF signal. This tuning can be observed with the “pick-up probe” that is inserted into the sample chamber. The RF field in the coil produces an emf in the two loops of the probe and that emf can be observed on an oscilloscope. Using this pick-up signal, the user can tune the sample coil to resonance by adjusting both the compression and the piston capacitors on the tuning side.

Changing the impedance matching capacitors (piston, compression, and fixed 900 pf) has a small effect on optimizing the RF power to the coil, but is important when using the spectrometer in CW mode. Since there is always at least 976 pf of matching capacitance, the sample probe is usually well enough matched for most pulsed NMR experiments.

However, when searching for a signal in the pulsed mode, it is essential that the coil be on, or nearly on, resonance with the RF frequency, and that the RF frequency be at, or nearly at, the precession frequency of the nuclei being measured. This is not difficult to achieve, since the magnet has the Larmor precession frequency of a proton sample written on the serial label. This label appears on both the magnet and the electronics Mainframe. Of course, this is not an exact number since the magnetic field in the gap is temperature dependent. It is, however, close enough for a student to see a signal if the RF sample probe is properly tuned to that frequency. It is very difficult to observe a signal if the sample coil is not tuned near the RF frequency of the synthesizer.

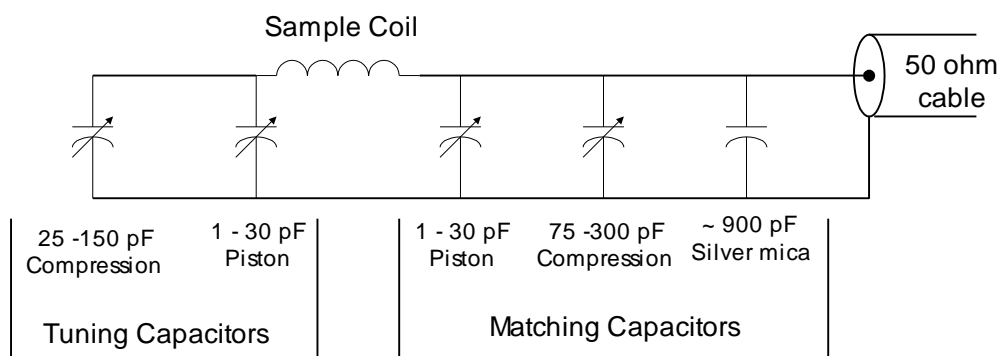

Figure 2.10 Circuit Diagram for RF Sample Probe

## I.2 Pickup Probe



Figure 2.11 RF Pickup Probe

Figure 2.11 shows a diagram of the RF pickup probe. As described above, this probe is essential in the early stages of tuning the RF sample probe to the Larmor precession frequency. There are no test points or pickoff points in the RF circuits, so we provided the user with this probe to examine the RF field DURING THE PULSE. The oscillating RF field in the coil produces an emf in the coil, and that emf, in turn, generates an oscillating voltage across the  $50\ \Omega$  load. This voltage can easily be observed on an oscilloscope, as shown in Figure 2.12.

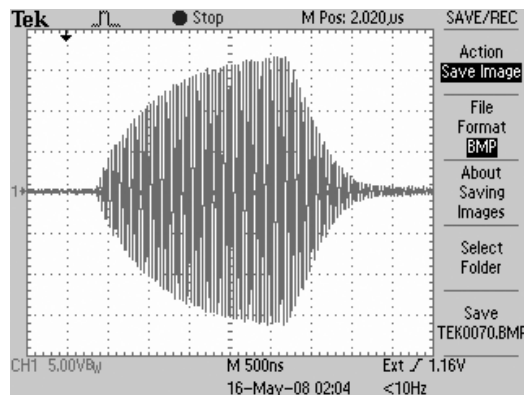

Figure 2.12 Pickup Signal During RF pulse

This voltage can be optimized primarily by adjusting the two tuning capacitors (25 – 150 pf compression, 1 – 30 pf piston) using the spectral tool provided. **BE CAREFUL NOT TO USE A STEEL SCREW DRIVER – THIS AREA HAS A LARGE MAGNETIC FIELD. YOU CAN DAMAGE THE MAGNET**

### III. GETTING STARTED

#### A. SPECTROMETER SET UP – PULSE MODE

There are three major parts to this spectrometer, the “MAGNET” (with RF Sample Probe mounted inside), the “MAINFRAME” (with the Receiver, Synthesizer, Pulse Programmer, Lock-In, and built-in DC Power supply) and the PS2 CONTROLLER (with Magnet Temperature and Field Gradient electronics). These three units are interconnected. All three are powered by a single regulated DC power supply (+ 5 V,  $\pm 15$  V) mounted inside the Mainframe case. You can see each of these components in Figure 3.1.

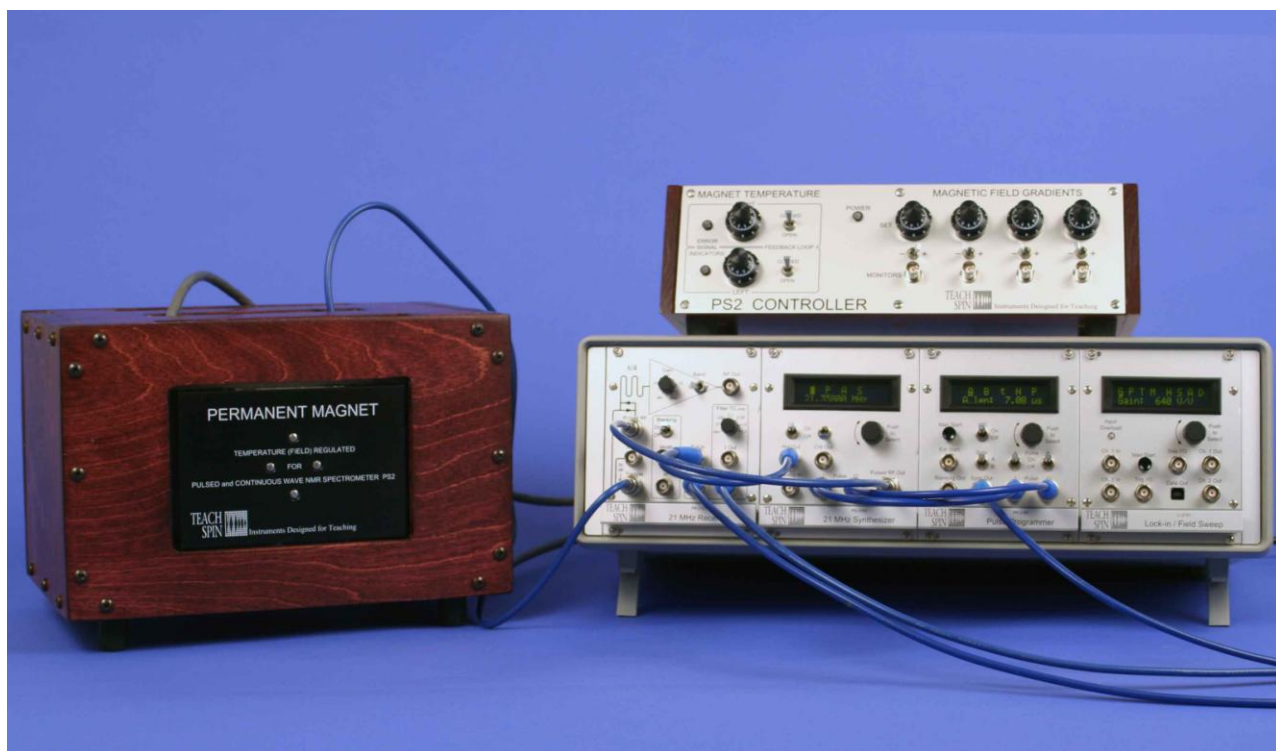

Figure 3.1 The PS2 Spectrometer: Magnet, Mainframe and PS2 Controller

Begin by connecting up these three units. The gray cable from the PS2 Controller marked DC Input Power connects to the rear of the Mainframe. The blue coaxial cable, with the reverse gender BNC connector, attaches to the Receiver reverse gender panel connector marked “**Sample**”. The gray cable from RF Sample Probe connects to the rear panel of the PS2 Controller marked “MAGNET GRADIENT/MODULATION”. The gray cable from the lower part of the case of the magnet connects to the rear panel of the PS2 Controller marked “MAGNET TEMPERATURE”. The AC power cable connects to the universal power entry plug on the rear of the Mainframe.

The rest of the connections are to be made with the blue BNC cables on the Mainframe and into your oscilloscope. TeachSpin recommends that students begin these experiments using a digital oscilloscope. A computer will also serve as a data storage device, but we believe it is more appropriate to use an oscilloscope first and then other options can be considered, after students have become thoroughly familiar with the spectrometer.

## Connections and Basic Settings for Pulse Mode

1. Connect the blue 18 inch reverse gender cable from Pulsed RF Out (Synth) to Pulsed RF In (Rec)
2. The following are connections made with 12 inch blue BNC Cables:  
 Q (PP) to Q (Synth)  
 I (PP) to I (Synth)  
 Blanking Out (PP) to Blanking in (Rec)  
 Ref Out (Synth) to Ref In (Rec)
3. The following are connections made with 36 inch blue BNC cables to a two channel digital oscilloscope:  
 Sync Out (PP) to Input Trigger  
 Env. Out (Rec) to Channel 1  
 Q Out or I Out (Rec) to Channel 2
4. Turn Off: CW Out (Synth), B Pulse (PP), MG (PP)  
 Toggle Sync to A (PP)  
 Toggle Pulse to A (PP)  
 Ref Out (Synth) –Toggle Turn On  
 Filter TC to .01 (Rec)  
 Gain to 75% (Rec)  
 Toggle Band to P (for proton) (Rec)  
 Toggle Blanking (Rec) On, Width 75% (Rec)

**Do NOT connect to:**

- Receiver – CW IN, RF Out
- Synthesizer – Sweep In, CW Out
- Pulse Programmer – Ext Start
- Lock-In – All Connectors.

If you have made all the connections specified, you have set up the spectrometer for your first experiments. Turn it on with the power switch you will find on the rear panel of the Mainframe, at the power entry plug. The only pilot lights that should go on are the one on the PS2 Controller and the “error signal indicators”. However, all three LCD displays should light up and initially display “TeachSpin”.

## B. DIGITAL SETTING OF PARAMETERS

### B.1 Overview

Before you attempt an experiment, you should get used to setting the parameters of the three digital modules. Three of the modules on PS2 Mainframe, the Synthesizer, the Pulse Programmer and the Lock-In/Field Sweep, are adjusted digitally with one knob in the upper right hand corner. With this control the experimenter first selects the parameter and then changes its value. The LCD screen at the top of the module displays both the name of the parameter and the value selected. It may take some practice to become proficient with this control, but in a short time students will have the muscle memory needed to adjust these units seamlessly.



There is one disadvantage to this control system. The current value of only **one** parameter appears on the screen at any given time. The values of the other parameters can easily be obtained by scrolling through the menu. However, only one value at a time can be viewed or changed. Of course, students can always record the values they have chosen for each of the parameters. We trust that data books may still be in fashion. We encourage writing!

## B.2 DEFAULT SETTINGS

The settings which have been preprogrammed into each unit of the PS2 Mainframe electronics are listed below. You should check these to assure that the unit is operating correctly. In each module, the parameter we have shown as underlined appears on the screen as underlined and is flashing.

SYNTHESIZER	PULSE PROGRAMMER	LOCK-IN / FIELD SWEEP
<u>F</u> (flashing) – Frequency: 18.00000 MHz P Refer Phase: -180° A CW Pwr: - 10 dBm S Sweep: 0 kHz/V	<u>A</u> (flashing) A_len: 0.02 μs B B_len: 0.02 μs $\tau$ tau: 0.0001 s N Num_B: 0 P Period: 0.2 ms	<u>G</u> (flashing) Gain: 80 V/V P Ref Phase: : -180° T Time Const: 0.5 s M Mod Amp: off H Fld off: 0.00 G S Swp Md: off A Swp Amp: 0.039 G D Swp Dur: 10 s

## B.3 SETTING PARAMETERS

The push-to-select” knob is used in three stages.

1. Rotate the knob to display the desired parameter.
2. Push the knob into the panel and hold for a second or two until a beep indicates that the parameter has been selected.
3. Now you can change the value of the selected parameter by rotating the knob until your chosen value is displayed.

This process might best be explained by an example. Consider the synthesizer. If the Mainframe power has just been turned on, the capital letter F is both underlined and flashing and the number 18.00000 MHz appears on the screen. There are four functions that can be selected and varied by this control. They are:

- F: the Frequency of the internal synthesizer
- P: the relative Phase of the reference signal being routed to the receiver module
- A: the Amplitude of the continuous wave (CW) rf output signal used when the spectrometer is configured for CW NMR detection.
- S: the Sweep of the NMR rf frequency which is also used in CW NMR detection.
- ↑: the arrow is not a parameter. It is actually part of the menu and is used to return the control knob to the choices on the upper line of the menu.

Suppose you wish to set the synthesizer frequency to 21.350 MHz, the Larmor precession frequency for your particular unit, which was marked on the serial number label. How do you do this? Since the letter F is flashing, the default program has already selected Frequency for you. If you simply turn the knob, you will see the selected parameter change to P (phase), A (CW power), S (sweep).

To activate the parameter you wish to set, in this case frequency, start with the F flashing and then push the knob into the panel and hold it in until you hear the beep. The flashing will stop, but the F will still be underlined. Another underline will then appear at the 0.1 MHz decade on the display. Turning the knob will now change the frequency by 0.10 MHz per “click”.

The coarse control of the frequency control has been activated and turning the knob can get us to 21.3 MHz, but that is not the value we want. Pushing in the knob and again waiting for the beep will move the underline to the .001 MHz position. Now, turning the knob will change the frequency in these smaller, 1 kHz steps. Another push and the underline will translate to .001 MHz or 10 Hz, the smallest frequency steps possible with the synthesizer.

By a combination of pushing and rotating, the entire menu of variables in each module can be accessed and the desired values assigned. Two things are important to remember. First, the chosen value of the parameter will only be set when the knob has been pushed in long enough for the “beep” to sound. This delay was installed to prevent accidental pushes, during rotations, from causing changes. Second, you must remember that the value of only ONE parameter at a time can be displayed. It might be wise to check all the parameters before beginning an experiment. Be sure to record these values!

An example: Perhaps you have “inherited” the spectrometer from your classmate who left the power on to the Mainframe. Supposing she was using it in the CW mode, with the frequency sweep option running. If you now attempt a pulsed experiment, without turning off the frequency sweep option, you will observe some bizarre signals. You might then incorrectly conclude that the spectrometer needs repair!

Even in a simple single  $90^\circ$  pulse experiment, where one is only observing the free precession decay (FID) of the proton spins, previously programmed parameters can cause serious problems. Suppose the period P (the time between repeated  $90^\circ$  pulses) is short compared to the spin-lattice relaxation time  $T_1$ . In such a case, the spins are not given sufficient time to return to thermal equilibrium magnetization before the  $90^\circ$  pulse of the RF occurs. Thus, the signal will be reduced in amplitude, possibly so much that it is not observable. There is nothing wrong with the spectrometer; it has just been set up incorrectly.

<b>IT IS ESSENTIAL THAT ALL THE PARAMETERS HAVE BEEN INTERROGATED AND RECORDED BEFORE EMBARKING ON AN EXPERIMENT.</b>
---

## C. SINGLE PULSE EXPERIMENTS

### C.1 Set Up

All of the experiments described in this section can be done with a single A pulse that is repeated with a period P. The first thing to do is to select a sample with a high density of protons. Mineral oil is a good choice. Two types are supplied with the unit. **It is essential that the correct volume of sample be used for all experiments.** Large errors are introduced into the measurements if too much sample is placed in the vials. The explanation for this systematic error is as follows:

The RF coil which surrounds the sample is a solenoid approximately 30 mm\* long. The RF field from such a solenoid is only reasonable uniform over about half of its overall length. Therefore, if the sample only fills about 5 mm of the tube and is placed so that those 5 mm are in the center of the solenoid, all the spins in the sample will experience nearly the same magnitude of the RF magnetic field during the pulse burst. Thus, all of the spins will be “rotated” (tipped) the same amount. Figure 3.2 shows the correct volume and placement of a sample. Note that the O-Ring stop is located 39 mm from the center of the sample. This places the sample both at the center of the RF solenoid and at the center of the gradient and modulation coils.

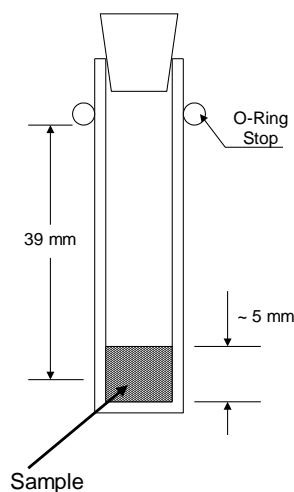

Figure 3.2 Schematic of Sample

Before you place the sample into the RF probe and search for your first NMR signal, you must tune the RF probe to the Larmor precession frequency of the proton in the ambient magnetic field. Since the spectrometer has no “pickoff points” in which you can examine the RF currents through the solenoid, TeachSpin has provided you with a “pickup probe” which can be inserted into the sample chamber to measure the RF fields DURING THE PULSE.

If the RF solenoid is tuned to resonance at the spectrometer’s synthesized frequency (by the two tuning capacitors in the RF Sample Probe), then the RF magnetic field will also be at a maximum in the coil. The inserted pickup probe’s voltage will also be a maximum when the sample solenoid is tuned to resonance.



Figure 3.3 Pickup Probe

Since the single solenoid coil in the RF Sample Probe serves as both a transmitter (to tip the spins) and a receiver (to produce an emf from the free precession of the magnetization), it is essential that it be tuned (or very nearly tuned) when searching for a signal. The unit is shipped from the factory tuned for a proton resonance. However, if this is your first attempt at PNMR with this unit, it is anybody’s guess how the last user has left the tuning capacitors on the RF Sample Probe.

**\*NOTE: In versions PS2-A and B the sample coil is 12 mm long unless it has been upgraded.**

Place the coil end of RF pickup probe in the center of the sample solenoid. Secure it in place. Attach the BNC connector to Channel 1 of your oscilloscope. (The oscilloscope should have a bandwidth of at least 30 MHz.)

- 1. Set the synthesizer frequency** to the frequency marked on the unit's labels. (Labels are on both the magnet and the Mainframe.)
- 2. Set A\_len** to 2.5  $\mu\text{s}$  (or longer)  
**Set P** to 100 ms  
Leave all other settings as they have been set
- 3. Set the parameters on the Oscilloscope**  
Trigger: Ext, Normal, Rising, > 0.1 Volt, positive slope  
Sweep: 2  $\mu\text{s}/\text{division}$   
Channel 1: 5 V/div, DC, Full bandwidth

With this time scale on your 'scope, you are observing the RF field inside the solenoid DURING THE PULSE. This is *not* a magnetic resonance signal. If the RF Sample Probe is properly tuned, you should observe an RF burst of about 40 volts peak-to-peak lasting about 3  $\mu\text{s}$ . Try adjusting the two capacitors **on the tuning side**.

The tuning side is the side near the gray cable (the left side) coming out of the RF Sample Probe. The capacitor nearest the sample hole is a piston capacitor (1 – 30 pf fine tuning) and the one farthest from the hole is the compression capacitor (25 – 150 pf coarse tuning). Changing these capacitors should have a dramatic effect on the amplitude of the pickup signal.

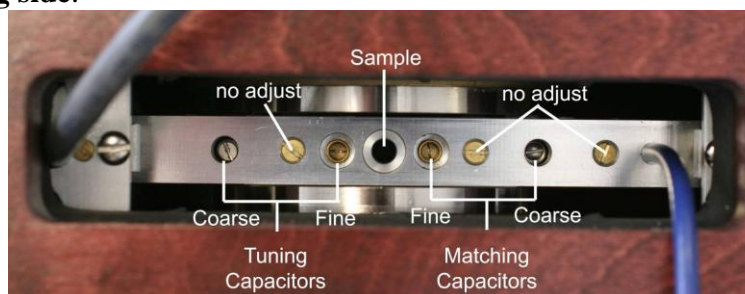

Figure 3.3b Tuning Capacitors Seen from Above

Adjust for maximum amplitude. If you cannot achieve about 40 V peak-to-peak voltage, something is wrong. Stop here and investigate the problem.

## C.2 Free Induction Decays, FID (Free Precession); Protons

You are now ready to do your first magnetic resonance experiment with the PS2. Start with one of the mineral oil samples. Since you now wish to observe the precessing magnetization (collection of spins) AFTER THE RF PULSE HAS BEEN TURNED OFF, you need to change the time scale on the oscilloscope. The RF burst that tips the magnetization from its thermal equilibrium orientation along the z-axis (the direction of the DC magnetic field) to create some transient component along the x-y plane, does so on a time scale of microseconds ( $10^{-6}$  s). But this x-y magnetization precesses in the x-y plane for times of the order of milliseconds ( $10^{-3}$  s). Thus, the sweep times on the oscilloscope should be adjusted to 0.5 – 1.0 ms/div. Channel 1 of the 'scope should be connected Env Out from the receiver.

The second input on the oscilloscope should be connected to either the I or the Q output from the receiver. Remember (see Ch. 2, Sec. A.1) that the I and Q outputs are the *product* of the signal from the precessing *spins* multiplied by the *reference* signal from the oscillator. The equation is:

$$\sin(\omega_{ref}t) \cdot \sin(\omega_{spins}t) = \frac{1}{2} \cos(\omega_{ref} - \omega_{spins})t - \frac{1}{2} \cos(\omega_{ref} + \omega_{spins})t$$

Since the term  $\omega_{ref} + \omega_{spins}$  is filtered out (it is approximately 40 MHz), it is the *difference signal* that is presented at the output. We call this the ‘beat’ or ‘difference’ signal. It is essential that the beat frequency be at, or near, zero so that the oscillator has the nearly the same frequency as the precession frequency of the spins being examined.

The upper trace in Figure 3.4, indicates that when this measurement was made, the system was not exactly ‘on resonance’, but it is very close and requires only a little tweaking. In many permanent magnet NMR systems, the precession frequency drifts because the temperature of the permanent magnet is not absolutely constant. Any change in the magnet temperature causes a change in the magnetic field  $\mathbf{B}_0$ , and thus in the precession frequency. The PS2, however, has a temperature, and thus a field, stability of one part per million over a span of over 25 minutes.

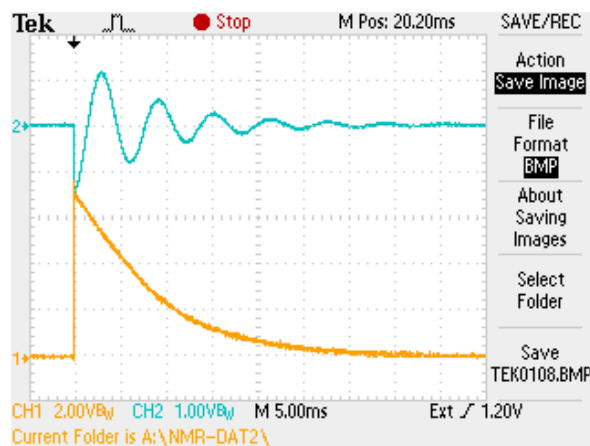

**Figure 3.4** – Upper Trace: Difference Signal  
Lower Trace: FID Envelope

***A word of warning before we proceed:*** Because of a phenomenon commonly referred to as ‘aliasing’, you may have a situation where an apparent zero beat signal is caused not by a perfect match between the oscillator and free precession frequencies but rather is due to the sampling pattern of the modern digital ‘scopes. The best way to be sure you have a true zero beat is to change the oscilloscope sweep rate for just a moment. If you have a true zero beat, the CH2 display will stay the same. If there is aliasing due to a sampling pattern, multiple beats will appear. This means you must go back and keep changing the oscillator frequency until you find the ‘real thing’. Another way to make sure you have a true zero beat is to change the acquisition mode of the ‘scope from a sampling mode to a peak-detection mode. In this case, a signal that looked as if it were zero beat will show voltages far from zero, indicating that the oscilloscope sampling pattern did not show the true character of the signal.

Set all four potentiometers on the PS2 Controller – field gradients X, Y, Z,  $Z^2$ , to zero. Place your mineral oil sample in the RF Sample Probe and look for an FID signal. You should see one on the oscilloscope. Now there are many parameters to play with. Study their effects on the FID signal. You should do just that – play with them – vary them – record your results. You should try to explain everything you observe. If you cannot, talk with your instructor. Some of the parameters to vary are listed below.

1. Gain	8. Phase
2. Filter TC	9. Magnetic Field Gradients
3. A_len (Pulse length)	10. Close the Temperature Control Loop
4. P period	11. Sample Placement in Solenoid
5. Tuning capacitors (RF Sample Probe)	12. Take the Fast Fourier Transform of the signal from either I or Q output from receiver – tune off resonance
6. Matching Capacitors	
7. Frequency	

The following is a list of things to do and questions you should be able to answer based on your experimentation with these single pulse measurements.

1. How do you know if you have a 90, 180, 270 or 360 degree “pulse”?
2. Calculate the approximate average  $B_1$  field during the pulse.
3. Describe the differences in the signals from I, Q, Env Outputs.
4. How would you measure the field stability of the magnet?
5. Plot the magnetic field as a function of time after you close the temperature control loop.
6. What is the effect of the filter time constant on the signal?
7. Using a single 90 degree pulse, plot the maximum signal amplitude as a function of the period (repetition time). Explain your data.
8. How do you determine that the spectrometer is “on resonance” – namely that the free precession frequency is the same as that of the spectrometer’s synthesizer?
9. Is there a signal when the spectrometer is off resonance? Explain. Suppose you tune it “way” off resonance? Is there a signal then? Keeping the  $A_{len}$  constant, tune the spectrometer’s frequency away from resonance and explain what you observe. (Note: you should adjust the tuning capacitor in the RF Sample Probe for the maximum signal amplitude as you change the frequency.) A careful examination of effective fields in the rotating coordinate system will greatly help you understand your data.
10. Adjust the magnetic field gradient coils several times. Figure 3.5 shows our data from the Env. Output. Can you achieve this long – or maybe longer decay times?
11. Place some distilled water in a vial and repeat some of these measurements. What is the decay time? How does the signal depend on the period, on pulse length ( $A_{len}$ , etc.? Explain what you observe. Which properties are the same and which are different between water and mineral oil?

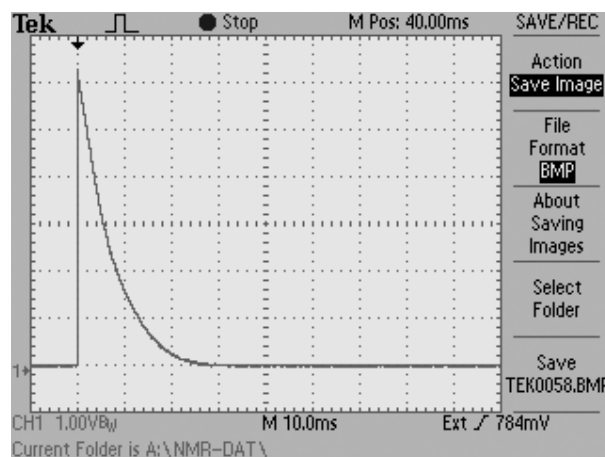

Figure 3.5 FID of Heavy Mineral Oil

### C.3 The 180° Pulse

The experimental criterion for obtaining a 180° pulse, that is an RF burst that rotates the thermal equilibrium magnetization from the + z to - z axis, is a pulse approximately twice as long as a 90° pulse, yet one that leaves no FID signal after it. Why no signal? Well, if this pulse has rotated the magnetization exactly 180°, it has left no component of  $M_0$  in the x-y plane. No x-y magnetization, no FID signal!

You may, however, have tried to obtain a 180° pulse and found a small signal after the pulse that you cannot eliminate by making the pulse time longer or shorter or even by changing the frequency. What is the problem?

To explain the effect, one must carefully examine what is happening during the RF pulse. When the signal for the pulse comes from the pulse programmer, the RF power is connected to the sample coil. An RF oscillating current rapidly builds up in the coil **at the synthesizer frequency**. It takes time, ( $\sim 0.2 \mu\text{s}$ ) to build up the current, since it is a tuned circuit. Then, the signal comes from the pulse programmer to turn off the current, to “open the switch” and end the pulse. The solenoid is disconnected from the synthesizer. But again, because the coil is part of a series resonant circuit, the current takes a finite time to die out. This is called “**ring-down**”.

Now, suppose that the resonant circuit of the sample coil was tuned to a frequency slightly different from the frequency of the synthesizer. When the coil is disconnected from the synthesizer, the RF oscillating current will decay to zero at this different frequency. Thus the spins have been subjected to **two different frequencies** during the entire burst of RF oscillating fields.

You should be able to show, with diagrams and by considering the effective field in the rotating frame, that one cannot obtain a true 180° pulse under this condition. One will always observe a FID signal after a pulse with two frequencies.

Luckily, you can easily eliminate the problem:

1. Tune the spectrometer to resonance and obtain the best 180° pulse possible by varying the pulse width.
2. Adjust the fine tuning capacitor in the RF Sample Probe a small amount. (Remember which way you changed it!)
3. Change the pulse width and see if the “tail” of the FID after the 180° pulse is smaller or larger. If it is smaller, continue to adjust the fine tuning the same direction. If larger, reverse your tuning direction.
4. Keep changing the pulse width and the tuning capacitor until you achieve a null after the 180° pulse.
5. Note, when you change the tuning capacitor, you are affecting **three** parameters of the spectrometer. They are:
  - a) The amplitude of the RF magnetic field during the pulse.
  - b) The “ring-down” frequency of the RF pulse.
  - c) The amplitude of the FID signal (because the effective gain of the receiver changes).

6. How do you know if you have correctly tuned the RF Sample Probe? If it is correctly tuned for pulsed signals, the following criteria should be met:
  - a) After a  $180^\circ$  pulse, there should be no (or very small) FID signal. You should achieve nearly perfect magnetization inversion.
  - b) The  $180^\circ$  pulse width should be approximately twice as long as the  $90^\circ$  pulse, that is a  $90^\circ$  is  $2.5 \mu\text{s}$ , a  $180^\circ$  is  $5\mu\text{s}$ .
  - c) The amplitude of the FID signal following a  $90^\circ$  pulse on a mineral oil sample should be comparable to the data taken at the factory and posted in this manual.
7. If the above criteria are not met, you may have tuned the system to some peculiar configuration that is incorrect. So start again.
  - a) First: make sure your synthesizer frequency is actually at the Larmor precession frequency of the spins. As we pointed out before, this is done by creating a zero beat signal on either the Q or I phase detector. ***Look out for aliasing effects on your digital oscilloscope. They can badly mislead you.***
  - b) Second: set the A pulse width (A\_len) to  $1\mu\text{s}$ , a pulse width that can, at best, produce about a  $40^\circ$  rotation of the magnetization. Set P to at least 0.3 seconds for a mineral oil sample. (For other samples, make sure P is at least three times the spin-lattice relaxation time.)
  - c) Now adjust the tuning capacitor to maximize the signal. Note: If the signal increases, it may be due to all three effects listed in item 5 above. As long as you have correctly set the synthesizer frequency to the Larmor frequency of the spins, any increase in the FID signal amplitude will bring the probe closer to the correct setting.
  - d) Change the pulse length to achieve a  $180^\circ$  pulse. Adjust the fine tuning capacitor to achieve a perfect  $180^\circ$  pulse as described in item 6 above.

What you are doing is simply tuning the series resonance circuit of the sample solenoid to the exact frequency of the synthesizer. When that has been accomplished, the spins only experience **one frequency** during the entire pulse burst. You should be able to achieve a near perfect result.

**This is the best way to tune the spectrometer for all pulsed experiments.** It assures that only one frequency is imposed on the spin system during the pulses. This “two frequency” effect cannot be observed from a  $90^\circ$  pulse, so it is best to tune the spectrometer with a  $180^\circ$  pulse before doing any experiments.



## C.4 Free Precession; Fluorine

### C.4.a Overview

The spectrometer comes with several fluorine liquids that should now be studied. In this spectrometer, the magnetic field is kept constant and it is the RF frequency that is changed to observe the fluorine NMR signals. It is necessary to retune the spectrometer to detect the fluorine free precession signals. But, before you do that, it is important to adjust the magnetic field gradient coils so that the field at the sample has its maximum homogeneity. This can best be accomplished with the protons in the water sample.

The data shown in Figure 3.5 shows a decay time of about 25 ms due to the field inhomogeneities over the sample. (At this time, you will have to accept our word for that causality. You will soon see decay times that are due to the sample.) You should be able to adjust your spectrometer to have at least 5 ms decay times

The adjustment of the field gradients should be done **with the temperature control loop closed** and the magnetic field stabilized. This will prevent the field and the field gradients from drifting during the upcoming measurements of fluorine signals. A fluorine nucleus has a smaller magnetic moment than the proton so that, in the same magnetic field, the resonance frequency of the fluorine will be lower than that of the proton by about 6%.

Important constants to note are:

Proton's NMR Frequency:	42.576 MHz/T
Fluorine's NMR Frequency:	40.044 MHz/T
$f_{\text{fluorine}}/f_{\text{proton}} = 0.9408$	

### C.4.b Fluorine Liquid FID

The following is a set of directions and questions to guide your exploration of the fluorine free induction decay signal.

1. Calculate the new resonant frequency for fluorine and set the frequency of the synthesizer to this new LOWER frequency.
2. Place the RF pickup probe in the sample chamber. Adjust the tuning capacitors in the RF Sample Probe for maximum signal. This should produce an approximately 40 volt peak-to-peak RF burst during the pulse.
3. Switch the BAND toggle on the receiver to f.
4. Start with the clear liquid sample labeled FC-770. Place a few drops in a sample vial. Place a black rubber stopper on it with an O-ring collar.

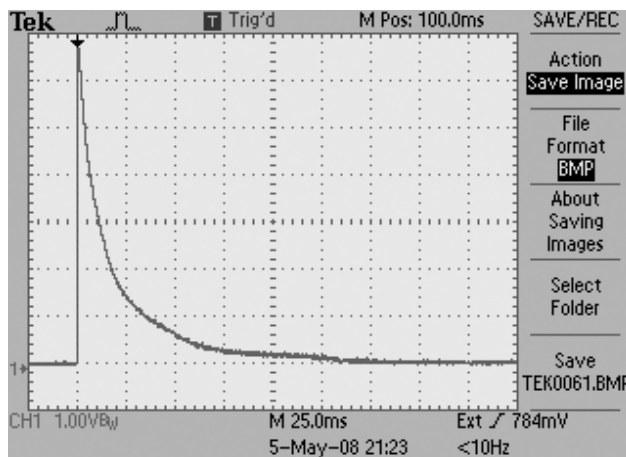

Figure 3.5 FID of Water Sample

- Adjust the A\_len to produce a  $180^\circ$  pulse.
- Tune the RF probe to achieve a near perfect  $180^\circ$  pulse (no “tail”).
- Adjust A\_len to produce a  $90^\circ$  pulse.
- Study the FID signal amplitude as a function of the period P. Vary P over a wide range and plot your data. Describe the ways this plot differs from what you found for the water and mineral oil samples.

## C.5 Fast Fourier Transform

The FID signal from FC-770 looks very different from the mineral oil or water sample. The decay time is shorter and clearly not exponential. The explanation of this signal starts by considering the possibility that there is more than one “kind” of fluorine atoms in this liquid. By “kind,” we do not mean different isotopes of fluorine. All of our nuclei are  $F^{19}$ . We mean that in this complex liquid, fluorine atoms may be located in different parts of the molecule with different local surroundings. These different local surroundings create different local magnetic fields. Since it is the total field at the nucleus that determines the nuclear precession frequency, different nuclear sites produce different precession frequencies. This very important property is essential for chemical and biological analysis of various samples. It has a name. It is called the **Chemical Shift**.

To analyze how many different fluorine sites there are in FC-770, we will look at the fast Fourier transform (FFT) of the FID signal from the phase sensitive detectors. To do this, it is essential that the spectrometer’s frequency be **off** resonance so that the FID signal from Q looks like Figure 3.5. The FFT of this signal is shown in Figure 3.6.

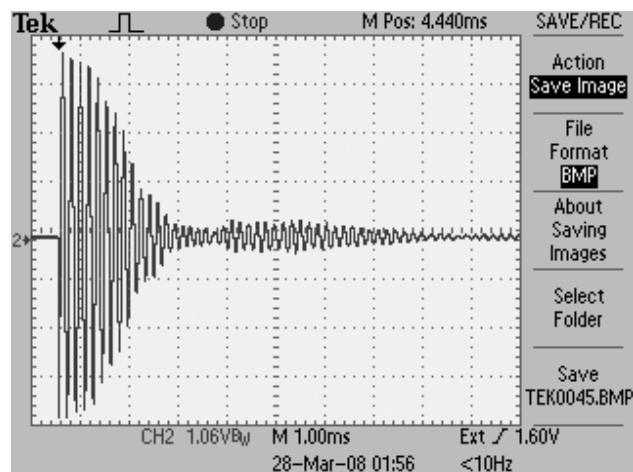

Figure 3.5 FID of FC-770

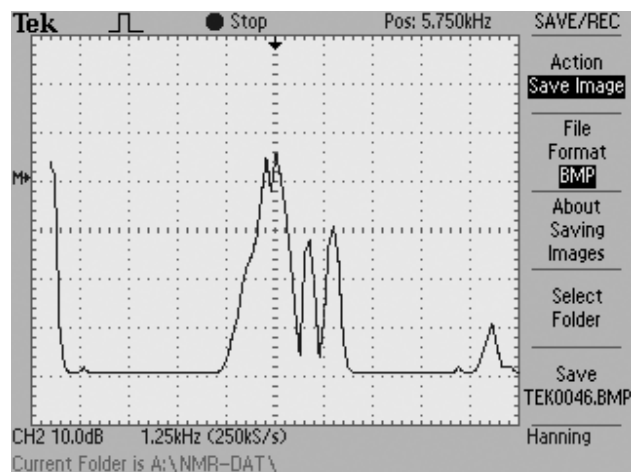

Figure 3.6 FFT of FC-770

Clearly Figure 3.6 shows that there are three distinct peaks indicating at least 3 inequivalent fluorine sites. One peak, however, may actually be two peaks that are very close together. There may also be a fifth peak at a much smaller intensity. Chemists, especially organic chemists, use this technique to identify certain atomic clusters in molecules.

One can examine these spectra for different repetition periods P. What does this tell you?

Why didn't we see chemical shifts in mineral oil? It turns out that fluorine atoms typically have much larger chemical shifts than protons. Proton chemical shifts can be observed in some liquids by carefully adjusting the gradient coils for optimum field homogeneity and using a substance where these shifts are large. We have observed proton chemical shifts in ethyl alcohol and toluene, and many other substances can be used. But all of the principles of studying "chemical shifts" can be learned with your PS2 using fluorine liquids. That's why we have provided you with several safe fluorine liquids to study.

## C.6 Fluorine Solids FID

What differences can be observed between solids and liquids? Teflon is a common solid worth studying with these simple one pulse experiments. How does the Teflon compare with the fluorine liquids? You may not know that there are several kinds of Teflon – some made from recycled material and some "virgin". You might want to see if they exhibit any different NMR properties.

## D. TWO PULSE EXPERIMENTS

Next we will consider experiments that have two pulses, A and B, which are separated in time. Here, a single pulse sequence consists of two bursts of RF magnetic field (whose length you can choose with  $A\_len$  and  $B\_len$ ) separated by a variable time,  $\tau$ . Thus, there are four parameters to program into the pulse programmer: A length, B length,  $\tau$  (the time between A and B), and P, the repetition time of the entire A, B cycle.

### D.1 Spin-Lattice Relaxation Time, $T_1$

#### D.1.a Overview

In the introduction section, we discussed the time it takes for the z-component of the magnetization to grow to its thermal equilibrium value. Equation 1.14 models the situation where the sample starts from zero magnetization  $M_z(0) = 0$  and grows to  $M(\infty) = M_0$ , its thermal equilibrium magnetization value.  $T_1$  is a very important physical parameter since it tells us about the mechanism of the spins interacting with their environment. There are materials that have  $T_1$  values as short as microseconds and some that have  $T_1$  values as long as several seconds. Let's examine some experimental ways of measuring it.

Actually, you have already made some crude estimates of  $T_1$ . You should have observed a decrease in the FID signal strength for decreasing repetition time P in the single pulse experiments. Sometimes, that decrease is not observed until  $P \sim 50$  ms and for other samples, the decrease was noticeable for  $P \sim 1$  second. The explanation for this, as you may have realized, is that too rapid a repetition time does not give sufficient time for the spins to return to their thermal equilibrium value before the  $90^\circ$  pulse. This condition is often referred to as **saturation**. By looking at these plots of signal vs. P, one can make a reasonable assessment as to the spin-lattice relaxation time.

### D.1.b Measuring $T_1$

But let's do better than this estimate. A good sample to start with is mineral oil. The best place to begin is with the differential equation that governs the process of the spins returning to their thermal equilibrium value (1.13).

$$\frac{dM_z(t)}{dt} = \frac{M_0 - M_z(t)}{T_1} \quad (1.13)$$

Now, however, we will consider a new set of **initial conditions**. The first pulse, A, will be a  $180^\circ$  pulse, which takes  $M_0$ , (in the + z direction) and rotates it  $180^\circ$  so that it is now in the - z direction. The magnetization will then return to  $M_0$  in the +z direction with a time constant of  $T_1$ . From the differential equation we can see that the rate of return is **proportional to the difference** between the instantaneous value of  $M_z(t)$  and the thermal equilibrium value  $M_0$ . Since the initial conditions are not the same as those described in Chapter 1, equation 1.14 will not be valid. It is the job of the student to derive and plot the mathematical equation that describes the way the magnetization returns to equilibrium after an initial  $180^\circ$  pulse.

Once the equation has been determined, an interesting problem arises. How do you determine the instantaneous value of  $M_z(t)$ ? Remember, the spectrometer never directly detects  $M_z$ . All of the spectrometer's NMR signals come from precessing magnetization **in the x-y plane**. This x-y precessing magnetization induces an emf in the sample coil. The "trick" is to follow the initial  $180^\circ$  pulse with a  **$90^\circ$  pulse to interrogate the z-magnetization**. This second pulse rotates the z-magnetization  $90^\circ$  into the x-y plane. The **initial amplitude** of the **FID** after the  $90^\circ$  pulse is proportional to the  $M_z$  magnetization **just before the pulse**. This two-pulse sequence is then repeated with different times,  $\tau$ , between the A and B pulses. Note that for  $\tau \gg T_1$ , the initial amplitude of the FID should be proportional to  $M_0$ .

Using this two pulse sequence, measure the  $T_1$  of your mineral oil sample. Do this in two ways.

1. There is a time,  $\tau_0$  such that the amplitude of the FID signal is zero. This *zero-crossing time* can be used to make a better estimate of  $T_1$ . Derive the expression for extracting  $T_1$  from this time measurement.
2. Plot your data in any way you can support and extract  $T_1$  from this plot. Estimate your systematic errors. Note: Having an accurate value of  $M_0$  (or a signal proportional to  $M_0$ ) is very important. Suppose, for example, that there is a 10% error in the measurement of  $M_0$ . How will that effect the measurement of  $T_1$ ? Think of some clever ways to determine  $M_0$  accurately.

**Warning:** All of the Bloch equations describing the spin systems start on the premise that the **spin system is in thermal equilibrium** before the first pulse is applied. Since these pulse sequences are applied every P seconds, it is essential that the spins be given adequate time after the last pulse in the sequence to recover to thermal equilibrium. How much time needed? At least  $3 T_1$ , or better yet,  $10 T_1$  for accurate measurements. **It is crucial to make a good estimate of  $T_1$  before you attempt an accurate experiment of any magnetic resonance parameter.**



relaxation time. The time interval,  $2\tau$ , between the  $180^\circ$  pulses should be short compared to the time of self diffusion of the spins through the field gradients. If that is the case, this sequence significantly reduces the effects of diffusion on the measurement of  $T_2$ .

### D.2.c.2 Meiboom-Gill

There is a serious practical problem with the Carr-Purcell pulse sequence. In any real experiment with real apparatus, it is not possible to adjust the pulse width and the frequency to produce an exact  $180^\circ$  pulse. If, for example, the spectrometer was producing  $182^\circ$  pulses, by the time the 20<sup>th</sup> pulse was turned on, the spectrometer would have accumulated a rotational error of  $60^\circ$ , a sizeable error. This error can be shown to affect the measurement of  $T_2$ . It gives values that are too small.

Meiboom and Gill devised a clever way to reduce this accumulated rotation error. Their pulse sequence provides a **phase shift** of  $90^\circ$  between the  $90^\circ$  and the  $180^\circ$  pulses which prevents the accumulated error to the first order. The M-G pulse train gives more accurate measurements of  $T_2$ . All of your final data on  $T_2$  should be made with the Meiboom-Gill phase shift **on**. The only reason it is not permanently built into the instrument is to allow you to see the difference in the echo train with and without this phase shift.

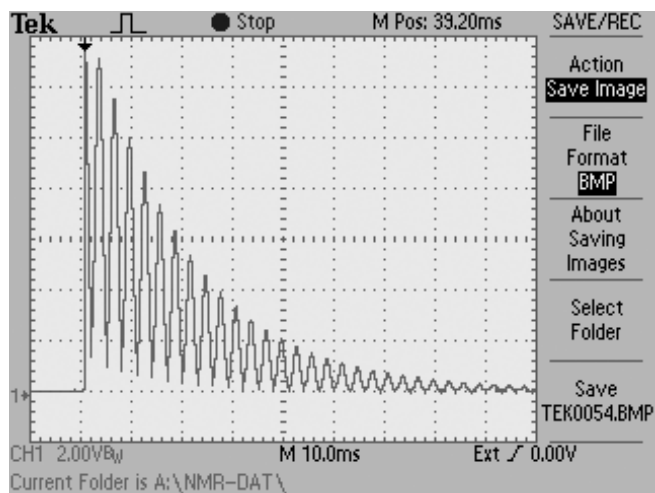

Figure 3.8 Meiboom-Gill Sequence

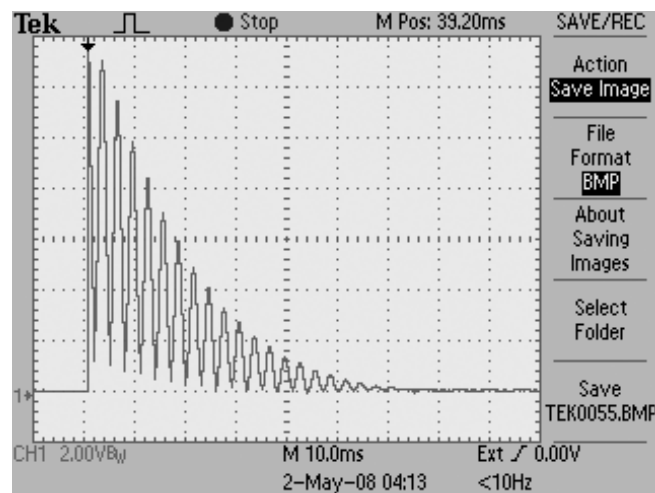

Figure 3.9 Carr-Purcell Sequence

### D.2.c.3 Self Diffusion

Carr and Purcell showed that self diffusion leads to the decay of the echo amplitude. For the case where the field gradient,  $\partial B/\partial z$ , is in the  $z$ -direction, the magnitude of the echo gradient as a function of delay time  $\tau$  is given by the expression:

$$M(\tau) = M_0 e^{-\gamma^2 \left(\frac{\partial B}{\partial z}\right)^2 \frac{D\tau^3}{12}} \quad (3.1)$$

If the sample is placed in a known field gradient, it is possible to use this pulse sequence to measure  $D$ , the diffusion constant. This is an advanced experiment to be attempted only after mastering the basic measurements of  $T_1$  and  $T_2$ .

## E. CONTINUOUS WAVE (CW) EXPERIMENTS

### E.1 Overview

Historically, NMR experiments were all done using some variation of what is called CW experiments. They are rarely carried out today, but it is worth a student's time to carry out a few CW experiments and to understand how to analyze the data they produce. All of these experiments use a continuous, rather than pulsed, radio frequency field which is imposed on a sample inside a coil or cavity. In some experiments the RF frequency is swept, but in the experiment we will consider, both the RF frequency and its amplitude remain constant. It is the magnetic field that is varied through the resonance condition. Consider the experimental set up shown in Figure 3.10.

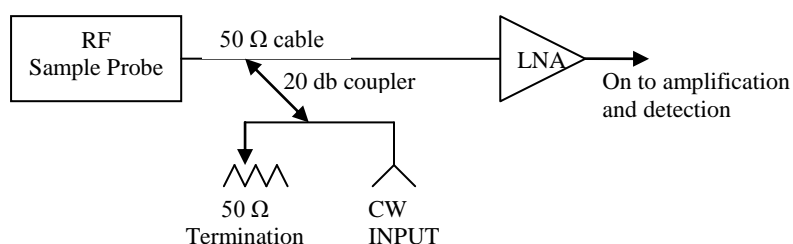

Figure 3.10 Schematic of Configuration for CW Experiments

Both the A and B pulses have been **turned off** and the CW OUT on the synthesizer is connected to the CW In on the receiver. The CW toggle is turned on. Remove the BNC cable from the Pulsed Power In connector. Now the spectrometer can be represented by the schematic shown in Figure 3.10. Here, the RF power is directed to the sample coil via the 20 db directional coupler. Most of the power goes to the 50 Ω termination, but one hundredth of the power travels down the 50 Ω cable towards the RF probe. That power excites the solenoid surrounding the sample.

Now, suppose you are clever enough to adjust the capacitors in the RF Sample Probe such that the impedance at the input of the probe is exactly 50 Ω, pure resistance. You have succeeded in exactly matching the input impedance of the probe to the cable's characteristic impedance. For such a case, there is **no** reflected signal from the probe and thus no signal that travels from the probe down to the Low Noise Amplifier (LNA). The output of the LNA is then only noise.

But this 50 Ω match was accomplished with a sample in the RF solenoid. The sample has a small, but very important effect on the inductance and the dissipation of this solenoid. The nuclear spins affect the inductance since they are magnetic and the spins' coupling to their local surroundings affects the dissipation in the coil. It is these small effects that are used to detect magnetic resonance.

Suppose the sample is now subjected to a DC magnetic field whose magnitude is slowly changed with time. If the magnetic field is swept through the so called "resonance condition" where  $B_0 = \omega/\gamma$  ( $\omega$  = angular frequency of the RF field), then both the inductance and the dissipation of the solenoid change. This change causes changes in the impedance match at the input to the RF probe. The probe is no longer matched. That means a reflection occurs at the input, sending a

signal down the cable to the LNA. This signal is then amplified, phase and amplitude detected and ultimately recorded.

This description is rather brief. It is advisable for a student to look up some references to obtain a more complete description which includes a mathematical analysis of CW resonance experiments.

## E.2 Probe Matching, Theory

How is it possible to match the RF Sample Probe to  $50\ \Omega$  (resistant impedance) when the only components inside the RF Sample Probe are capacitors and an inductor? The inductor's resistance is much smaller than  $50\ \Omega$ . Here is an explanation.

Consider a simple series resonant RCL circuit with component values R, C, and L. The impedance of the series combination of these three elements,  $Z_S$ , is simply the sum of their individual impedances,

$$Z_S = Z_R + Z_C + Z_L \quad (3.2)$$

For each element, the impedance is simply the sum of the real (resistive) part R and the reactive (imaginary) part X,  $Z = R + X$ . For each component these are:

$$X_R = R \quad (3.3)$$

$$X_C = \frac{-i}{\omega C} \quad (3.4)$$

$$X_L = i\omega L \quad (3.5)$$

We can write  $Z_S$  in terms of resistance and reactances as:

$$Z_S = R + X_C + X_L = R + X_S \quad (3.6)$$

where we have defined  $X_S = X_C + X_L$  as the sum of the reactance of the sample coil and its series tuning capacitor.

Since the last element in the circuit (the matching capacitor) is going to be added in parallel with series combination of the above three elements, we want to convert the value of  $Z_S$  into an admittance,  $Y_S = 1/Z_S$ . (Admittance is the complex equivalent of a conductance, so for parallel combination you simply add admittances.)

$$Y_S = \frac{1}{Z_S} = \frac{1}{R + X_S} \quad (3.7)$$

The admittance may be expressed as a sum of its real part, the conductance, G and its imaginary part, the susceptance, B.

$$Y_S = G_S + B_S = \frac{1}{R + X_S} = \frac{R - X_S}{R^2 - X_S^2} \quad (3.8)$$



We can make the identifications  $G_S = \frac{R}{R^2 - X_S^2}$  and  $B_S = \frac{-X_S}{R^2 - X_S^2}$

We want to match to a  $50 \Omega$  load which has an admittance ( $1/50 \Omega + 0i$ ), so we want to choose  $X$  so that  $G_S = 0.02 S$ .

Consider the form of  $G_S$ , recalling that  $X$  is imaginary, so that  $X^2$  is negative.  $G_S$  is a Lorentzian with a peak value of  $1/R$  when  $X = 0$ . This makes sense because, on resonance, the reactive component vanishes and we simply have the conductance of the series resistor, which models the loss in the resonant circuit. Values of  $R$  are on the order of  $0.5 \Omega$  which makes the peak of  $G_S$  about  $2S$ . To match to  $50 \Omega$  we need a conductance of about  $0.02 S$ , so we de-tune the resonant circuit, increasing the value of  $-X^2$  (which is positive) until  $G_S = 0.02 S$ . We can achieve this by detuning the resonant circuit either above or below the operating frequency,  $\omega$ .

Now that we have the real part of the admittance matched, consider the form of the imaginary part, the susceptance.

$$B_S = \frac{-X_S}{R^2 - X_S^2} = \frac{i(1/\omega C - \omega L)}{R^2 - X_S^2} \quad (3.9)$$

$B_S$  is imaginary and looks roughly like the derivative of a Lorentzian. At frequencies below resonance, its imaginary component is positive, and at frequencies above resonance, its imaginary part is negative. **We choose to detune the circuit so that we are operating a frequencies above the natural resonance**, so that  $B_S$  is negative. We then simply add a matching capacitor in parallel which has a positive susceptance of  $B_m = i\omega C_m$  to cancel the negative susceptance of the detuned series resonant combination. ( $B_m$  is simply the reciprocal of the capacitive reactance of the matching capacitor,  $X_C = -i/\omega C_m$ ).

### E.3 Observing a CW Resonance

In several ways, CW resonance experiments are more difficult (and produce less accessible data) than pulsed experiments. We will take you through the details of the CW experiment using an FC-43 fluorine liquid sample.

Begin by adjusting the magnetic field gradients for optimum field homogeneity using a proton sample (water). Now retune the spectrometer to observe a fluorine FID signal. The FID signal from FC-43 and its FFT are shown in Figure 3.10 and Figure 3.11.

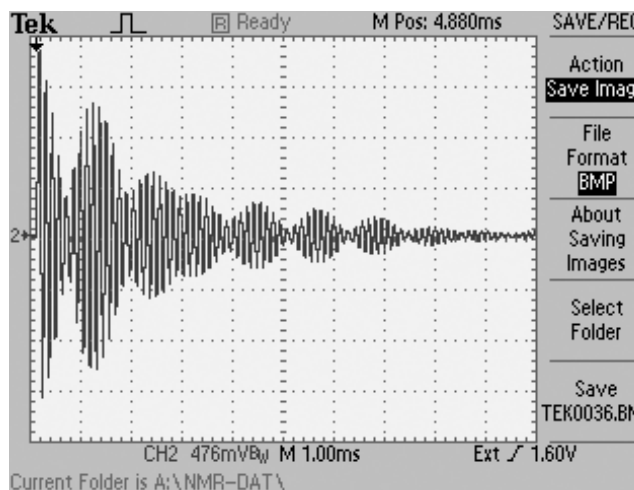

Figure 3.11 FID FC-43

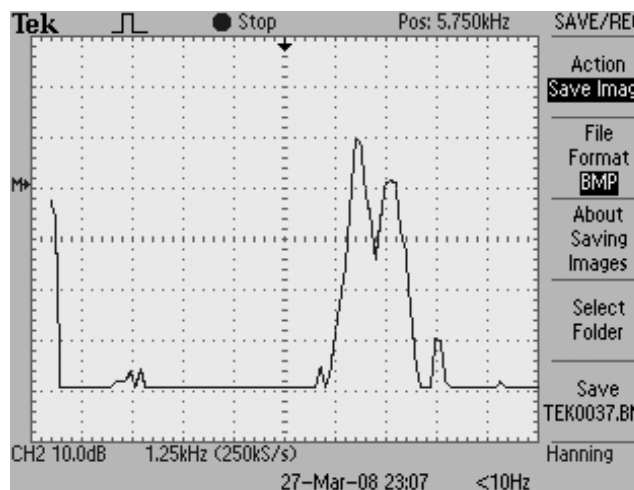

Figure 3.12 FFT FC-43

It is clear from the FFT that FC-43 has at least two inequivalent fluorine sites separated by 1 kHz (0.8 div x 1.25 kHz/div). Performing a CW scan of this sample, we would expect to observe two resonances separated by 1 kHz in frequency “space” or by 0.25 gauss in magnetic field “space”.

However, before we can observe the CW resonance, the capacitors in the RF must be adjusted for a very good impedance match. This may take some time, especially the first time. How does one know that the coil is almost exactly impedance matched? There is a straight forward procedure which is outlined below:

1. Set up your oscilloscope for the x-y display and adjust the offset controls so that the single spot is at the center for all gain settings with the DC coupling and the INPUT grounded.
2. Now connect the output from I and Q to inputs 1 and 2 on the ‘scope. (It does not matter which output goes to which input – but the scope must be **DC coupled**.)
3. On the synthesizer module, go on the menu to A and adjust for minimum output, namely -65 dbm (65 db below one milliwatt). The synthesizer frequency should have been set at the resonant frequency needed to observe the FID signal on the FC-43 fluorine sample.
4. Increase the CW power level and observe the spot on the x-y display on the ‘scope. (Set the gains on x and y to 100 mV/div.) The spot will move away from center indicating a reflected signal from the probe. Use a receiver time constant of 3.3 ms to filter the signal.
5. Adjust both the tuning capacitor and the matching capacitor to return the spot to the center.
6. Increase the rf power and repeat the tuning. Do NOT saturate the amplifiers (this changes their input impedance) with too much power. Keep the power low enough to adjust the spot back to the match condition. This will take some practice. If you initially change the tuning capacitor in the wrong direction, you will not be able to achieve a match condition. (See E.2) When you are near match, the match becomes quite sensitive to changes in the matching capacitor. Final adjustments must be made with the matching plunger fine control capacitor.

7. Now you are ready to search for a CW resonant signal. You need to sweep the magnetic field over a large enough range so that you can observe the entire signal and slow enough so that you allow all the low-pass filters in the system to remain in quasi static equilibrium. The magnetic field sweep is done through the Lock-In module. The Swp IO connector provides a voltage out proportional to the field sweep. Parameters you can vary are:
1. RF Power
  2. RF Phase
  3. Sweep Amplitude
  4. Sweep Time
  5. RC Time Constant
  6. I,Q, Env Detector
8. Compare your FFT, FID and CW signals. Are they compatible? Why are CW resonant experiments almost obsolete? How can you extract  $T_1$  and  $T_2$  from the CW data? Was the CW “splitting” predictable. Does one method give better signal-to-noise than the other? Explain.

Figure 3.13 shows our data for FC-43 under the following conditions:

RF Power: 10 dBm

TC: 3.3 ms

Phase:  $100^\circ$

Sweep Amplitude: 0.625 gauss for 5 div  
on scope (half scale)

Oscilloscope:

Scale: 200 mV/div, TC 3.3 ms,

x-y display:

x-axis connected to Swp I/O (Lock-In)

y-axis to Q out (Rec)

Temperature Control Loop Closed

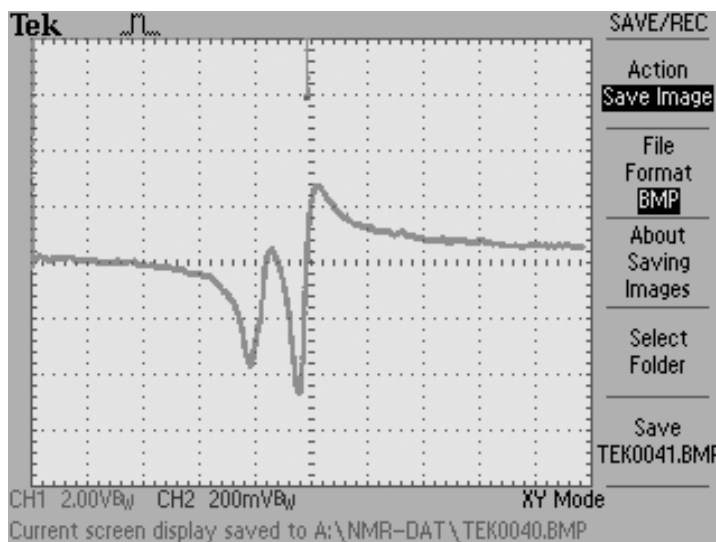

Figure 3.13 Data for FC-43

Note: I have “cheated” you a little here. We added an RC low-pass filter, with 10 k and 10  $\mu$ f; RC  $\sim$  0.1 seconds, between the Q out and the oscilloscope. This greatly reduced the 60 Hz pickup that we experienced taking this data. You may want to add such a simple filter to your apparatus. But, be careful to take it into account when you set your sweep rates. This pickup can be greatly reduced by keeping the magnet far away from any 60 Hz magnetic fields. These fields are strong near the transformer of the power supply inside the Mainframe. Keep the magnet as far away from the Mainframe as possible. Also, keep it away from the AC power lines in our lab.

## IV. EXPERIMENTS

The PS2 instruments are research grade Pulsed/CW NMR spectrometers capable of carrying out a wide variety of experiments and research projects. In this brief section, we are listing, in no particular order, experiments that instructors might wish to consider for their laboratory programs. This is certainly not an encyclopedic list; rather, it is a collection of experiments that will provide a challenging experience to both undergraduate and graduate students. All of the experiments require a careful reading of the literature to obtain a thorough explanation of the physics behind the experiments.

1. Measure  $T_1$  and  $T_2$  of water doped with paramagnetic ions over a wide concentration range. Paramagnetic ions that dissolve in water include  $\text{CuSO}_4$  and  $\text{Fe}(\text{NO}_3)_3$ .
2. Measure  $T_1$  and  $T_2$  in glycerin and water mixtures.  
Glycerin and water mix in any ratio. The motion of the protons in glycerin is significantly changed by the change of the liquid viscosity with the addition of water. The relaxation times can be correlated with the viscosity of the liquid, as well as with the water concentration.
3. Measure  $T_1$  and  $T_2$  in mineral oil with solvents. The relaxation times of protons in mineral oil diluted with organic solvents show the effects of diffusion and correlation times.
4. Measure  $T_1$  and  $T_2$  in Petroleum Jelly  
Vaseline is not a solid. The two relaxation times indicate fast molecular motion which is characteristic of a liquid. Samples can be heated and  $T_1$ , as well as  $T_2$ , can be estimated as the sample cools to room temperature. Other organic greases with sufficient proton concentrations can also be studied.
5. Biological Materials  
Most biological materials have protons, usually in water molecules. Measurements of  $T_1$  and  $T_2$  in biological materials give detailed information about the local environment of these water molecules. This area of exploration is wide open. This might be an area appropriate for an undergraduate research participation project.
6. Discover inequivalent fluorine nuclei in the various fluorine liquids that come with the spectrometer; HT-110, FC-43, FC-70, and FC-770.  
Look up their chemical structure and identify the various fluorine sites.
7. "Watch" epoxy cure. Study  $T_1$  and  $T_2$  of various slow curing epoxies and explain the data.
8. Rubber is a peculiar substance. Use various pencil erasers as samples. Study  $T_1$  and  $T_2$  as an eraser cools. You will have to estimate the temperature, since it is difficult to measure the temperature when the eraser is in the sample coil.
9. Can you observe inequivalent protons in Ethel alcohol? What about in an echo sequence?
10. Measure spin diffusion in distilled water.
11. There are well known fluorine greases. Measure  $T_1$  and  $T_2$  in those salt solids.
13. Examine virgin and recycled TEFLON. Can you distinguish them from their NMR data?
14. Explore the One-Dimensional Imaging possibilities described in Chapter V.

## V. ONE-DIMENSIONAL PNMR IMAGING EXPERIMENTS

### A. EQUIPMENT

1. PS2-C, or PS2-A or B with modified RF sample coil (see instructions for replacing RF sample coil)
2. 1-D Imaging Starter Kit (1D-A)
3. SR770 Spectrum analyzer or suitable math program on a digital oscilloscope

### B. INTRODUCTION

MRI, magnetic resonance imaging, is one of the most important applications of Pulsed-NMR physics. Although it is a vast and truly complex subject, TeachSpin has created a set of experiments to introduce undergraduates to this field. These experiments give the student the opportunity to design, control, manipulate and execute the relevant parameters and, in the process, they will gain a significant understanding of MRI technology. This pedagogy involves experiments in one-dimensional imaging looking at the proton (hydrogen nucleus) magnetic resonance signal.

What do we mean by one-dimensional imaging? In our case, with our cylindrical sample vials, the logical choice for the direction of variation is the axis of the cylinder. Fig 1 shows the sample vial with a layered sample and the spatial coordinates identified. Each layer contains either a different sample material or a spacer, which is a dielectric material that has no hydrogen atoms (Teflon).

Now instead of providing both spatially uniform and constant magnetic field in the z-direction, we apply a non-uniform B field such that:

$$B_z(x,y,z) = B_{oz} + k \frac{\partial B_z}{\partial y}$$

For the PS2 spectrometers, that is accomplished by adjusting the  $\frac{\partial B_z}{\partial y}$  gradient current control on the PS2 Controller.

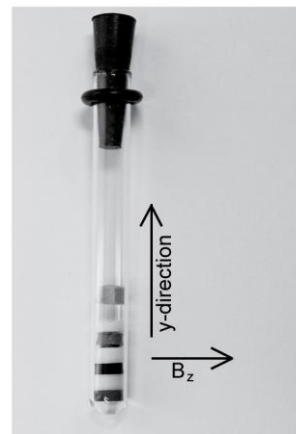
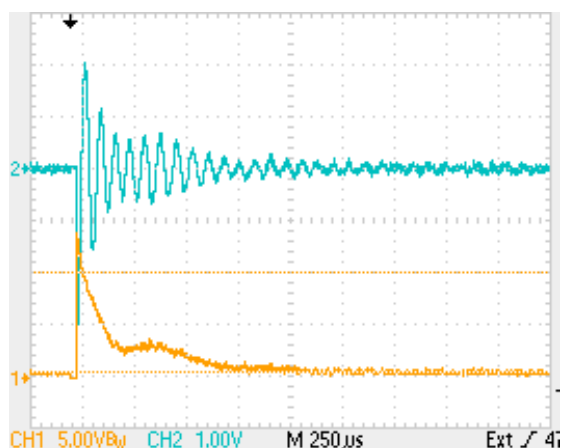

**Fig. 1. Layered Sample**

Given this magnetic field gradient, the protons in each segment of the sample have a Larmor precession frequency that depends on its location along the y-axis of the “stack”. *The existence of the gradient field allows the mapping of the position “y” in coordinate space to a location in frequency space.*

Suppose we apply a  $90^\circ$  rf pulse to a layered sample placed in such a gradient field. The free induction decay signal (FID) after the pulse will contain the Larmor frequencies of all the spins in the sample. To examine this FID with our 100 kHz spectrum analyzer, we use the PS2's frequency synthesizer to heterodyne the approximately 20MHz signal down to the kHz range, where it can be measured with high resolution and precision.

Let's look at a simple example of a two layered sample using two different soft waxes. Figure 2 shows the oscilloscope traces of both the envelope and phase detector outputs from the receiver. The signal in the time domain is not as informative as the same signal analyzed in the frequency domain and shown in Figure 3. It is clear that the FID contains two primary frequencies, in this case at 11 kHz and 13 kHz. Students can vary the y-gradient and observe that the splitting of these two peaks depends linearly on the current in the y-gradient field coils.



**Fig. 2** FID signals on a digital oscilloscope. Lower trace is from the envelope detector and the upper trace is the signal from the Q output.

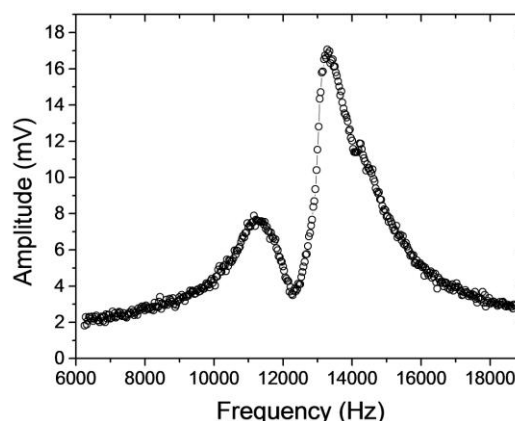

**Fig. 3.** FID signal from Q, phase detector examined on the SR770 spectrum analyzer.

## C. EXPERIMENTS

### C.1 Gradient Field

To more completely understand the FID signals from these layered samples, you must first measure the characteristic of the static magnetic field with a full y-gradient. This can be carried out using either a small liquid sample or a thin slab of a soft solid with a long  $T_2$  (narrow line width) which you can place in different locations along the y-axis. (Be careful if you choose a liquid sample because the liquid may not only be at the bottom of the vial but some may be above or along the walls). You will need to search through the soft solids in the kit to find one with a long  $T_2$ .

You need to determine the magnetic field gradient and homogeneity with full y-gradient. This will be accomplished with the FID signal following a 90° pulse, heterodyned down to the kHz range, and measured by the SR770 spectrum analyzer (or other FFT programs). This will yield both the central Larmor frequency and the line width of the signal.

Begin by adjusting the gradient controller, with the sample in the center of field, for the best field homogeneity. If you use a mineral oil sample, you should obtain  $T_2^* > 5$  msec. There should be only small current needed in y-gradient control.\*

Now, turn the y-controller to maximum current and monitor that current using the output on the controller.

- Make a graph (with two distinct vertical axes) of the central frequency and the line width as a function of the position of the small sample. Do this for at least two y-gradient currents.
- How long of a layered sample is reasonable to use? Why?
- What happens when you change the heterodyne frequency you use? Does that affect the measurement of the gradient or the homogeneity?
- This plot is your “map” that allows you to associate a location in frequency space with a position in coordinate space, the MRI image.

## C2. Sample NMR Parameters

Soft solids are the ideal material to create a layered sample for imaging experiments. Being solid, they are easily formed into layered sample. However, the hydrogen nuclei in these materials have NMR properties that are close to those in liquids, making them ideal for PNMR measurements of  $T_1$  and  $T_2$ . The “kit” has a large collection of soft solids, both in bulk form and in pre-cut disks. It also has a custom cutting tool for making your own disk sample from materials you choose. (Please read section IV, which explains the proper way to use and maintain this cutting tool). Most of the “bulk” materials can be melted (with a heat gun) into the sample vials so as to create a custom layered sample.

Before you begin examining layered samples, you should measure  $T_1$  and  $T_2$  of some of these materials. These parameters will be useful in identifying various layers as you create a one-dimensional image from the PNMR data.

Why would a substance with a long  $T_2$  be helpful in constructing and image? Explain

\* *If this is not the case, you or your instructor should begin by turning off all the gradient currents. With the T-handle Allen wrench adjust the pole face of the magnet to optimize an FID signal from a small mineral oil sample for the longest  $T_2^*$ . Then adjust all the four gradient controls to maximize  $T_2^*$ . The y-gradient current should be near zero. In short, one should be able to nearly eliminate y-gradient currents using the mechanical adjustments of the pole faces.*

Can you imagine how you could use the spin lattice relaxation time,  $T_1$ , to identify layers?

The “standard” method for measuring  $T_1$  is the so called inversion-recovery, using a  $180^\circ$ -delay- $90^\circ$  FID pulse sequence. The “zero crossing” of the FID signal gives a reasonably good measure of  $T_1$ , which can be compared to a simpler, but cruder method described below.

Consider a single  $90^\circ$  pulse experiment where  $P$  is the repetition time between  $90^\circ$  pulses. Suppose we repeat these  $90^\circ$  pulses in a time period such that the initial magnetization after the pulse is only 90% of its thermal equilibrium (maximum) value.

You should be able to show that this occurs when

$$P = 2.3T_1 \quad \text{or} \quad T_1 = P/2.3$$

Thus by recording the repetition period  $P$  that causes the amplitude of the spectral peak of the FFT (on the SR770) to decrease 10% we can easily calculate an estimate for  $T_1$  for that material.

Compare the two methods of measuring  $T_1$ . What are the sources of errors?

### C3. Layered Samples

Now you are ready to study layered samples. Start with a simple two or three layer sample and use the thick Teflon spacers to separate the layers. This will make identification easier. Since you may be using different FFT programs, we will not provide you with a step-by-step procedure for creating the FFT. But we will list some of the things you should be aware of as you design your experiments.

- a.) The windowing on the FFT is important. For the SR770 use a uniform window.
- b.) Whether you are above or below the Larmor frequency with the heterodyning signal does matter. Why? What does it affect?
- c.) How can you use the pulse repetition time to help identify a particular layer in the sample?
- d.) How do you convert frequency to position in space? How do you distinguish between the top and bottom layers?
- e.) Why do we exclude hard solids from these experiments?

Now is the time to be creative. Bring in your own samples. Make some samples with thick and some with thin spacers. Make samples with no spacers. How about a layered meat with fat, connective tissue, and cartilage in it? What about plant materials, vegetables, fruits, etc? I suggest you make an unknown sample for your partner and she/he makes one for you. Then see if you can each make one-dimensional images of each other's samples.

Here is your chance to be creative. Have fun!



## D. CUSTOM CUTTING TOOL

Your ID-A kit contains a custom cutting tool for you to create disk samples that fit tightly into the PS2's sample vials. Proper use of this tool is essential.

The tool is designed to cut soft solids **ONLY**, such as plastic, rubber, wood, vegetable matter, etc. It is not designed to cut hard objects such as metals. The cutting edge is 304 stainless steel.

The tool should be mounted in a drill press with its chuck holding the brass end. The rotation speed can vary with materials.

The tool can cut many disks before it must be removed from the chuck. The individual disks are then pushed out from the end with the 1/8" diameter brass push rod provided.

The material to be cut should be placed on a **wooden** surface (not metal) so as not to dull the sharpened edge of the cutter.

The tool can easily be sharpened with a fine grit sander, or a fine file. Sharpen the outside edge first, then sharpen the inside edge with a fine round file.

We would like to encourage you to make your own samples from all kinds of both manufactured materials and material found in nature. Almost everything has hydrogen in it.

## E. KIT PARTS LIST

(Note: Material for soft solid disks can be obtained from McMaster-Carr. The catalog number listed next to each description)

### Pre-cut Disks

Buna-N #9023K543  
 EPDM #8610K91  
 Silicone Ultra Soft #9010K82  
 NeoPreme High Strength #8456K61  
 Buna- N- High Strength #9028K52  
 Silicone Ultra Strength #5787T61  
 Silicone Ultra Strong #5781T48  
 Silicone FDA # 86045K42  
 Silicone Extreme Temp #93755K31  
 Neopreme Super Soft #9109K611  
 PVC Type 1 # 87875K62  
 Teflon .032 #8711K93  
 Teflon .062 # 8545K13

### Bulk Soft Solids

Vaseline  
 Chapstick  
 Snow-proof  
 Minwax  
 Silicone Vacuum Grease  
 Bees wax with solvent  
 Candle wax with solvent

### Miscellaneous

Cutting Tool  
 Push Rod  
 10 Glass vials  
 5 o-rings

# Specifications for PS2 TeachSpin's Pulsed/CW NMR

## Magnet

Field:  $0.5 \pm 0.02$  Tesla

Homogeneity: (min) 0.5 mT over  $0.1 \text{ cm}^3$

Stability: 1 part in  $2 \times 10^6$

$$\frac{\partial B_z}{\partial x}, \frac{\partial B_z}{\partial y} = 7.1(\mu\text{T} / \text{mm}) / \text{Amp}$$

$$\frac{\partial B_z}{\partial z} = 6.6 (\mu\text{T} / \text{mm}) / \text{amp}$$

$$\frac{\partial^2 B_z}{\partial z^2} = 20(\mu\text{T} / \text{mm}^2) / \text{Amp}$$

$$\Delta B_z = 3.1 \text{mT} / \text{Amp} / \text{sweep}$$

## Synthesizer

Frequency: 1 – 30 MHz

Stability:  $\pm 50$  ppm

Frequency Increments: 100 kHz, 1 kHz,  
10 Hz

Phase:  $-180^\circ$  to  $+180^\circ$  in  $1^\circ$  steps

CW Amplitude:  $-10$  dBm to  $-65$  dBm,  
in 1dB steps

Sweep: 0, 1, 2, 5, 10, 20 kHz/V

## Pulse Programmer

A pulse:  $0.20 - 20.0 \mu\text{s}$

B pulse:  $0.20 - 20.2 \mu\text{s}$

$\tau$  tau:  $0.0001 - 9.999$  s

Number of B: 0 – 100

Period:  $0.2$  ms –  $100$  s

External Start: TTL 4 V,  $1 \mu\text{s}$

Manual Start

Snyc: either A or B pulse,  $0.5 \mu\text{s}$  TTL

## Receiver

LNA: Gain 20 Bb, NF 2.5 dB

VGA: Gain 0 – 80 dB

Band Switch: P, F

TC:  $0.001$  ms –  $3.3$  ms

Outputs: RF, Env, Q, I

Variable Blanking

## Lock-In/Field Sweep

Modulation Freq: 20 Hz

Gain: 80 V/Vrms to 2650 V/Vrms

Phase:  $360^\circ$  in  $1^\circ$  steps

Time Const.: 0.5 to 10.0 s

Field Sweep:  $-250$  mA to  $+250$  mA  
in a wide variety of formats

## RF Sample Probe

Tunable for protons and fluorine

Matched  $50 \Omega$  impedance

## Included

RF pickup probe

Complete set of BNC connectors (8)

50 Sample Vials, caps, O-rings, case

Test Samples: (2 ml) FC-770, PFS-1,  
HT-110, FC-70, FC-43, Glycerin,  
Light and Heavy Mineral Oil

One-Dimensional Imaging Kit (C and later)

Instruction Manual with Sample Data

# A Conceptual Tour of Pulsed NMR\*

Many nuclei, but not all, possess both a magnetic moment,  $\mu$ , and an angular momentum,  $L$ . Such particles are said to have spin. When the angular momentum and magnetic moment are collinear, as they are in protons (hydrogen nuclei) and fluorine nuclei, both the particle and its surroundings can be investigated using various techniques of Nuclear Magnetic Resonance Spectroscopy. For these particles, the quantity  $\mu/L$ , defined as the gyromagnetic ratio, is an important signature by which the particle can be identified and its behavior predicted or interpreted.

For our “tour” we will consider a specific collection of these magnetic nuclei, the protons in a liquid mineral oil sample. In the absence of a magnetic field, the spin axes of these particles are randomly oriented; there is no **net magnetization,  $M$** , of the sample. We will begin our NMR experiment by placing our sample into a magnetic field,  $B_0$ . For PS2-A this is the field of our permanent magnet. There is *no instantaneous* net magnetization. In time, however, a net magnetization does develop which is collinear with the direction of our  $B_0$  field. This is the **thermal-equilibrium condition**. The time constant for the build-up of this **net magnetization,  $M$** , which is almost always exponential, is called the **spin-lattice relaxation time,  $T_1$** . (For certain kinds of MRI, the “image” is nothing more than a grayscale map of the  $T_1$  for the tissue.)

We’ll begin our discussion of TeachSpin’s Pulsed NMR with the probe head tuned to investigate protons and our proton containing mineral oil sample already located in the field of the magnet and the net magnetization of the spins already in the thermal equilibrium condition.

Figure 1 shows a side view sketch of the basic system. The sample sits in the **Sample coil**, a tightly wound solenoid which has its axis perpendicular to the constant magnetic field,  $B_0$ , of the permanent magnet. This coil serves **two** purposes. In the role of **transmitter coil**, it supplies an oscillating RF (radio frequency) field which can change the orientation of the net magnetization. In the vernacular, we say that the RF pulse “tips the spins” away from the  $B_0$  direction. After such an RF pulse, the net magnetization vector will then freely precess around  $B_0$ . Once the spins have been tipped, the solenoid switches roles to become a **pickup coil** “sensing” the precession of any component of the magnetization which is in x-y plane. This three-dimensional process is easier to understand with some diagrams.

Figure 1 is a very simplified schematic. Figure 2, shows the relative directions of the magnetic fields we are discussing. The cylinder represents the solenoid/sample coil. The dark arrows represent the field,  $B_0$ , created by the permanent magnet. The thermal equilibrium magnetization of the protons is represented by the thinner arrow labeled  $M_0$ . The dashed double ended arrow,  $B_1$ , shows the direction of the oscillating RF field used to tip the spins

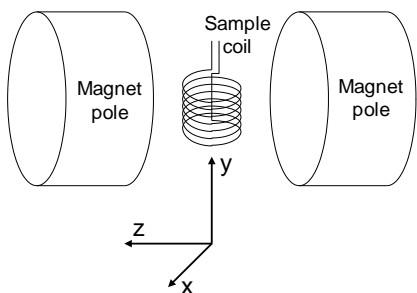

Figure 1 – Artist Sketch of Basic System

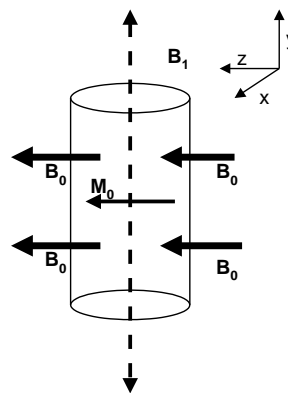

Figure 2 – Vector Fields

\* This “tour” is a *conceptual* introduction to the basic ideas of NMR and the way they can be explored with the TeachSpin apparatus. For hands-on operation, the manual is the best guide.

The duration of a short burst of the RF field, (a pulse) can be adjusted to cause the magnetization  $\mathbf{M}$  to rotate into the x-y plane. For the pulsed experiments we will be describing, it is important that the frequency of the oscillating RF matches the **Larmor frequency**, the frequency at which protons precess around  $\mathbf{B}_0$ . In this “on resonance” condition, if a pulse lasting some time  $t$  tips the spins into the x-y plane, a pulse lasting twice as long,  $2t$ , will tip the spins until the net magnetization is pointing in a direction, opposite to  $\mathbf{B}_0$ . In NMR jargon, these are referred to as  $90^\circ$  and  $180^\circ$  pulses. (TeachSpin’s Magnetic Torque apparatus provides a hands-on classical analog for this spin-flip mechanism.)

Figure 3a is a top view of the sample before and after a  $90^\circ$  pulse. In this view, the oscillating RF field  $\mathbf{B}_1$  is directed perpendicular to the page. The gray line labeled  $\mathbf{M}_0$  represents the initial thermal equilibrium magnetization of the spins parallel to  $\mathbf{B}_0$ . The vector  $\mathbf{M}_T$  represents the net magnetization of the sample the instant that the  $90^\circ$  RF pulse has ended. The net magnetization has been rotated into the x-y plane and will now precess, as shown in Figure 3b. This “free” precession creates an alternating emf in the solenoid surrounding the sample. This is clearly a non-equilibrium or transient condition. The rate at which the amplitude of the free precession signal diminishes, and the causes for that decrease, will be discussed later.

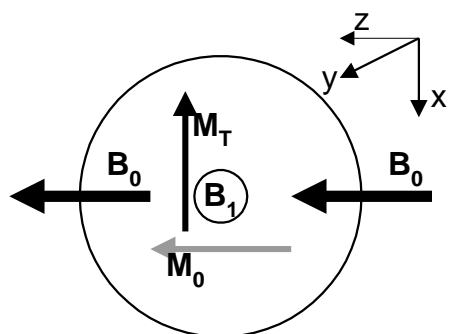

Fig. 3a Top view of the Sample showing the effect of a  $90^\circ$  pulse on the magnetization  $\mathbf{M}$  of the sample. The thermal equilibrium magnetization  $\mathbf{M}_0$  has been rotated to the transient  $\mathbf{M}_T$ .

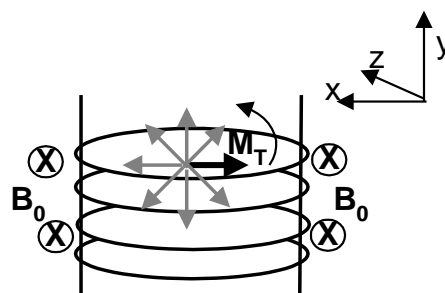

Fig. 3b Side view of the sample with  $\mathbf{B}_0$ , the field of the permanent magnet, directed into the page. Following a  $90^\circ$  pulse, the net magnetization,  $\mathbf{M}_T$  precesses around  $\mathbf{B}_0$ .

The PS2-A electronics system is composed of four modules, only three of which are involved in Pulsed NMR. The black knobs on the **Synthesizer** and **Pulse Programmer** are used first to select the aspect of the signal to be changed, and then rotated to change magnitude. The RF signal used to “tip” the spins is created by the **Synthesizer**. The **Pulse Programmer** module is used to determine the duration and spacing of the RF signals produced by the Synthesizer. The **Receiver** plays several roles. The connection labeled **Sample** first transmits the RF pulse to the solenoid surrounding the sample to tip the spins and then receives the resulting signal coming from the free precessing spins.

Let’s follow the progression of the signal. The module is in bold; the connector titles are shown in parenthesis. **Pulse Programmer** (*Pulse Out*) ► (*Pulse In*) **Synthesizer** (*Pulsed RF Out*) ► (*Pulsed RF*) **Receiver** (*Sample*) ► Solenoid acts as RF transmitter > Spins “tip” > Solenoid acts as Pickup Coil ► (*Sample*) **Receiver** (*Env. Out*) ► Oscilloscope, Channel 1

One role of the **Receiver** module is to amplify and “forward” the signal coming from the solenoid/pickup coil. As the spins precess inside the solenoid, they induce a voltage which rises and falls as a sine wave with each rotation. The sinusoidal signal can be observed at the *RF Out* connector. The signal usually associated with NMR, however, and shown in the lower trace of the oscilloscope capture in Figure 4, comes from the connector labeled *Env. Out* (envelope out). In this case, the signal is first “rectified” so that all values become positive and then only the maximum amplitudes for each cycle are selected. It is this rectified envelope which is referred to as the **free induction decay or FID**.

Set on *F*, the **Synthesizer** module displays the frequency in MHz of the RF (radio frequency) pulse being used to tip the spins, and change the direction of the net magnetization of the sample. As we have mentioned, for on resonance operation, this frequency must be adjusted to match, with high precision, the Larmor precession frequency of the protons in the field of the permanent magnet. (In TeachSpin’s Magnetic Torque simulation, this is equivalent to the frequency at which the small rotating field accessory is turned by hand.)

The **Receiver** module also houses the electronics which are used monitor the relationship between the **Synthesizer** and Larmor frequencies. As already discussed, the portion of the **Synthesizer** signal coming from the connector labeled *Pulsed RF Out*, enters the **Receiver** via connection *Pulsed RF* and is then used to tip the spins of the sample.

Another portion of the synthesized signal becomes a reference signal that is used to monitor the Synthesizer/Free Precession frequency match. It goes from the **Synthesizer** connector *Ref Out* into the *Ref In* connector of the **Receiver**. An internal connection in the **Receiver** diverts part of the signal coming from the precessing protons to a phase detector system where it is “multiplied” with the reference signal coming from the **Synthesizer**. The output is monitored from either the *I Out* or *Q Out* connector on the **Receiver**. This is the signal shown as the upper trace of Figure 4.

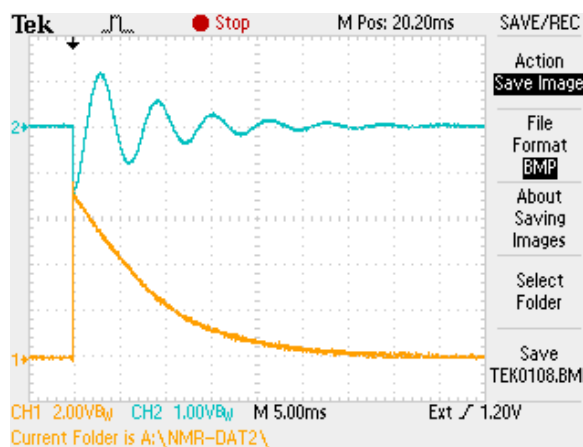

**Figure 4** – Upper Trace: Mixer Signal  
Lower Trace: FID Envelope

But how does this signal multiplication work; how does it tell us if we are on resonance? We get an answer to this by looking at what happens when we “multiply” two sine wave expressions mathematically. If the synthesized frequency is  $\omega_1$  and the free precession frequency is  $\omega_2$ , a bit of trigonometry gives  $2 \sin\omega_1 \sin \omega_2 = \cos (\omega_1 - \omega_2) + \cos (\omega_1 + \omega_2)$ . A low pass filter inside the **Receiver** allows only difference signals to reach the *I* and *Q* outputs. When the oscillator is properly tuned to the resonant frequency  $\omega_1 = \omega_2$  and the signal from either of the phase detector outputs should show no “beats.” The upper trace of Figure 4 indicates that when this measurement was made the system was not exactly “on resonance,” but is very close and requires only a little tweaking. In many permanent magnet NMR systems, the precession frequency drifts because the temperature of the permanent magnet is not absolutely constant. Any change in magnet temperature causes a change in the magnetic field  $B_0$  and thus in the precession frequency. The PS2-A, however, has a temperature and thus field stability of one part per million over 25 minutes.

The **Pulse Programmer** determines the duration of individual RF pulses as well as the number of pulses in a series, the spacing between pulses, and how often an entire series is repeated. The PS2 pulse programmer provides two different pulses, A and B, both at the same frequency. Duration and number of pulses, however, are independent. The selected pulse pattern is sent from the *Pulse Out* connectors of the **Pulse Programmer** to the *Pulse In* connectors of the **Synthesizer**. For the experiments in this discussion, *Sync Out* connects to the oscilloscope. The *Sync* toggle switch can be set to either pulse. Now let's look at how each of the pulse parameters is controlled by the settings on the **Pulse Programmer**.

*A\_len* and *B\_len* control the length of time each of these RF pulses persists. (In the Magnetic Torque apparatus, this "pulse" time is equivalent to how long you must rotate the horizontal field to get the ball's handle, and thus its magnetic moment, horizontal.)

*N* indicates the number of pulses to be used. The PS2 provides only one A pulse, but there can be anywhere from 0 to 100 B pulses in a given series.

The  $\tau$  setting indicates the delay time, the time between the first and second pulses of a series. When more than two pulses are used, the system adjusts subsequent delay times between the second and third, third and fourth etc. to  $2\tau$ . We will see why this matters later.

The *P*, or Period setting determines how often an entire pulse sequence is repeated. This is also called the repetition time.

The total time for the pulse series itself, is determined by the combination of *N* and  $\tau$ . This must be less than the repetition time *P* so that the digital logic does not lock up. In addition, *P* must be long enough so that, after the pulse series had ended, the net magnetization has time to realign with the primary field. If *P* is too short, a pulse sequence will begin before the system has returned to thermal equilibrium and the FID will make little sense. **In fact the repetition time *P*, should be such that the time after the last echo or FID is long compared to  $T_1$ . To be safe it should be close to  $10T_1$ .**

## Describing Relaxation Time

As we have discussed, the Pulsed NMR experiments we are describing involve the sum of the magnetic moments of many protons, the net magnetization. (By contrast, Magnetic Torque works with the spin of only one "proton" which is represented by the ball.) When the sample is in thermal equilibrium, the net magnetization of the protons of the sample is aligned with the field of the permanent magnet,  $\mathbf{B}_0$ . Any change in the orientation of the spins decays back to an alignment with this "primary" field. The time constant of this usually exponential return to thermal equilibrium magnetization is the  $T_1$  relaxation time. But TeachSpin's PS2 can actually be used to measure two **different kinds of relaxation times**, referred to as  $T_1$  and  $T_2$ .  $T_1$ , the **spin-lattice** relaxation time already described, is the time characteristic of establishing thermal-equilibrium magnetization in the  $\mathbf{B}_0$  direction. The **spin-spin** relaxation time,  $T_2$ , is the time constant for the exponential loss of x-y magnetization due to dephasing of the spins. The variation in the "local" field surrounding individual protons, which is created by magnetic properties of nearby atoms, changes the local precession frequency. This dephasing is thus an indication of important qualities of the sample.

## A First Exploration

Once the probe-head of the TeachSpin Pulsed NMR has been tuned to the proton frequency, we can investigate the PNMR signal following a single pulse. The duration of TeachSpin's A and B pulses are set independently. Start with both pulse widths set to 0, the repetition time,  $P$ , set to about 0.10 seconds, the A pulse on, the B pulse off and the oscilloscope triggering on A.

Slowly increase the A pulse length and examine the effect. (To be sure the RF pulse is in resonance, check the phase signal on the oscilloscope and tweak the **Synthesizer** frequency until there is a zero beat condition.) Pulse length determines the time allowed for the RF to tip the spins. The longer the RF is on, the farther the spins tip. As the time,  $A_{len}$ , increases, you will notice that the initial height of the FID (the signal on the oscilloscope) first rises to a maximum, indicating a  $90^\circ$  pulse, then decreases to close to 0 at about twice the  $90^\circ$  pulse time. This indicates a  $180^\circ$  rotation. After a  $180^\circ$  rotation there is no x-y magnetization and thus no signal. Continuing to increase the pulse time shows the signal increase to another maximum for a  $270^\circ$  rotation etc.

The repetition time can be used to estimate  $T_1$ , the time characteristic of re-establishing thermal equilibrium magnetization in the z-direction. Set the A pulse length for the first maximum. Decrease the repetition time,  $P$ , until the signal maximum begins to shrink. This decrease in the initial height of the FID occurs because the z-magnetization has not returned to its thermal equilibrium value before the next  $90^\circ$  pulse. We have found a rough measure of  $T_1$ . This effect becomes more dramatic as the repetition time decreases.

### Measuring $T_1$ , the spin-lattice relaxation time

(Time characteristic of establishing equilibrium magnetization in the z-direction)

A more precise measurement of  $T_1$  requires a two pulse sequence. The net magnetization,  $M_0$ , is first tipped by  $180^\circ$  to  $-M_0$  or the  $-z$  direction. The z-magnetization is then interrogated as it returns to its thermal equilibrium value,  $M_0$ . We have a problem however. Our spectrometer cannot directly detect  $M_z$ . Only precession in the x-y plane induces an emf in the sample coil. The "trick" we will use is to follow this initial  $180^\circ$  pulse with a  $90^\circ$  B pulse.

To tip the magnetization to  $-M_0$ , the length of the A pulse is increased until it has passed through the first maximum and returned to a 0 signal on the oscilloscope. This indicates a  $180^\circ$  pulse after which there is no net magnetization in the x-y plane. The A pulse is then turned off and the width of the B pulse is adjusted to the first maximum signal, indicating a  $90^\circ$  pulse.

The key to this experiment is the fact that the B pulse, which tips *any* spin by  $90^\circ$ , is being used to interrogate what has happened to the magnetization along the z axis. This second pulse rotates the z-magnetization into the x-y plane where it can be detected. The maximum amplitude of the Free Induction decay (FID) signal which follows the B pulse is directly proportional to the magnitude of  $M_z$  at the time the B pulse occurs. For example, if the delay time for B, following A, were to be 0, the signal would be at a maximum because the spins would be tipped from  $-z$  to the x-y plane.

By changing the delay time between the A and B pulses, the rate at which the net magnetization returns to alignment with the "primary" magnetic field can be investigated. When the delay time results in a 0 signal in the pickup coil, it means that the net magnetization along the z-axis is zero. When the signal again reaches a maximum, the spins have "relaxed" back to alignment along the z-axis. Careful observation of the Q or I phase detector signal will show a  $180^\circ$  phase shift as the z-axis magnetization passes through 0.

If the maximum amplitude,  $M$ , of the FID following the  $90^\circ$  pulse is plotted against the delay time, the relaxation of the spins from  $-z$  to  $+z$  can be observed. To extract  $T_1$  correctly, however, the difference between the FID maximum for long delay times, which is a measure of the thermal equilibrium magnetization, and the FID maxima at time  $t$  is plotted against delay time. It is this difference,  $M_0 - M$ , which changes exponentially. The equation is:

$$\frac{dM_z(t)}{dt} = \frac{M_0 - M_z(t)}{T_1}$$

An arbitrary scale can be used to plot the magnitude of the initial FID signal after the B pulse as a function of delay time. From the shape of this curve,  $T_1$  can be calculated.

Figure 5 shows diagrams of both the actual net magnetization  $M$  and the maximum amplitude of the FID just after the  $90^\circ$  pulse as a function of time.

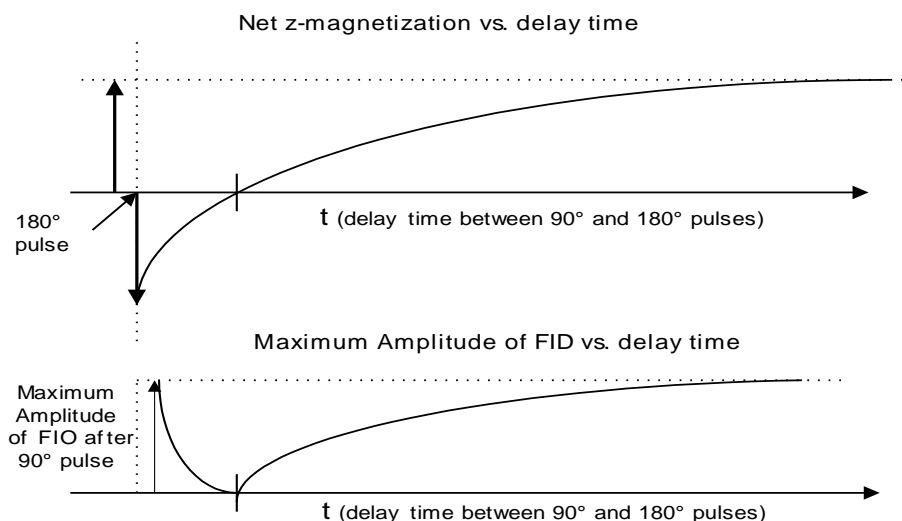

**Figure 5** – Upper Diagram: Net z magnetization vs. delay time  
 Lower Diagram: Maximum Amplitude of FID vs. delay time

### Measuring $T_2$ , the spin-spin relaxation time (The time characteristic of the loss of x-y magnetization)

The characteristic time for the spins to lose a non-thermal equilibrium x-y magnetization, which has been established by a  $90^\circ$  RF pulse, is called  $T_2$ . To measure this relaxation time, the width of the A pulse is adjusted to the first maximum signal, indicating a  $90^\circ$  pulse. The oscilloscope must trigger on A.

In the pick-up coil, the precessing spins induce a sinusoidally varying voltage which decays over time. As discussed at the beginning, the detector transmits only the absolute value of the maximum voltages during each precession. The rectified envelope represents the free induction decay or FID. Spin-spin relaxation occurs by two mechanisms:

1. The spins re-orient along the  $+z$  axis of the main magnetic field,  $B_0$  due to stochastic,  $T_1$ , processes.
2. The interaction of the spins themselves creates a variation in the local magnetic field of individual atoms. Because their precession frequency is proportional to the magnitude of the local magnetic field, the precessing spins dephase.



## Understanding T<sub>2</sub>\*

If the external magnetic field across the sample is not perfectly homogenous, spins in different physical locations will precess at different rates. This means that the precession of the individual spins is no longer in phase. Over time, the phase difference between the precessions of the individual protons increases and the net voltage induced in the pick-up coil decreases. The time for this loss of signal, which is not due to relaxation processes, is called T<sub>2</sub>\*. The free induction decay observed after a single 90° pulse is often due primarily to this effect. If, however, the external magnetic field is very homogeneous and T<sub>2</sub>\* is long compared to T<sub>2</sub>, the free induction will represent a true measure of T<sub>2</sub>. As good as the PS2 magnet is, it is not perfect. If the T<sub>2</sub> of the sample is less than 0.5 ms, the FID time constant can be used as a good measure of the real T<sub>2</sub>. However, if the spin-spin relaxation time of the sample is longer than a few milliseconds we will need to use a spin echo experiment to measure it.

## Spin Echo

In 1950, Irwin Hahn found a way to compensate for the apparent decay of the x-y magnetization due to inhomogeneity in an external magnetic field. The external inhomogeneity creates a variation in the proton precession times around an average. The introduction of a 180° pulse, or spin flip, allows the spins to regroup before again dephasing. This creates a *spin echo* which allows us to measure the true T<sub>2</sub>.

After our initial 90° pulse, the spins in areas of stronger than average fields precess faster than average and those in weaker fields more slowly. The spins “dephase” and the induced emf fades. After the 180° flip, however, the spins that were “ahead” because they are in a stronger field are now “behind.” Because their protons are precessing faster, however, they will now “catch up” to the “average.” In the same way, after the 180° pulse, “slow” spins are now “ahead” and the “average” will overtake them. The spins rephase momentarily and dephase again. This is why the oscilloscope trace after the first 180° pulse shows a rise to a maximum and then a decay. The initial dephasing and then the rephasing and dephasing wings of the echo can be seen in the diagram below. The difference between the height of the initial signal and the echo maximum is due to the actual stochastic processes of T<sub>2</sub>.

The magnitude T<sub>2</sub> can be investigated two ways. The time between the A and B pulses can be varied and T<sub>2</sub> determined by plotting the resulting echo maximum as a function of time. Another option is to introduce a series of 180° B pulses and look at the decrease of the maxima.

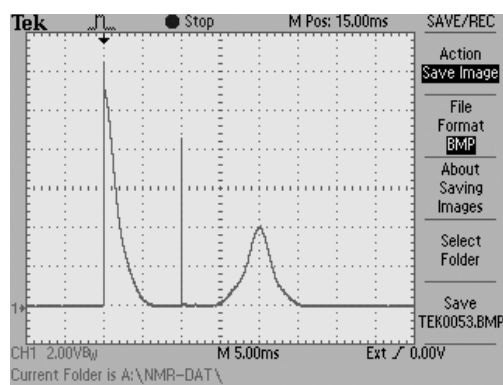

Figure 6a: Oscilloscope trace showing 180° pulse spike and spin echo.

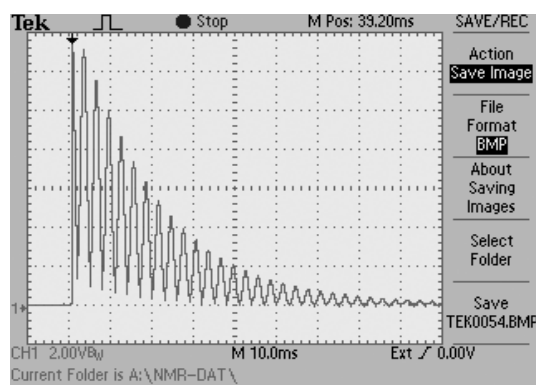

Figure 6 – Oscilloscope Trace of Multiple Echoes

## Understanding the effect of the 180° Spin Flip - a Jonathan Reichert analogy

Consider the plight of a kindergarten teacher who must devise a foot race which keeps all children happy, no matter how fast they run. What if the race has the following rules? All children are to line up at the starting line. At the first whistle they are to run as fast as they can down the field. At the second whistle they are to turn around and run back toward the starting line. First person back wins!! Of course, it is a tie, except for the ones who “interfere” with one another or fall down. As the children run away the field spreads out with the fastest ones getting farther and farther ahead. At some point there is no semblance of order. On the trip back, as the faster ones overtake the slow guys now in the lead, the group comes together again “rephasing” as they pass the start line.

This is a good analogy for the effect of the 180° spin flip which creates a spin echo. The effect of the 180° pulse is analogous to that of the kindergarten whistle. After the 180° pulse, the signal increases as the spins rephase, hitting a maximum somewhat lower than the initial height of the FID and decreasing as the spins again dephase. The decay of the maxima shows how the protons are losing the x-y magnetization. In our kindergarten analogy, this tells us the rate at which the children are actually interacting with each other.

### The Output of the Mixer as a Phase Indicator

During a  $T_1$  measurement the output of the mixer can be used to determine when the direction of the magnetization changes from the minus to the plus z direction. This cannot be inferred from detector output because it always gives a positive signal on the oscilloscope. By watching the mixer as delay time is changed you can see when the magnetization passes through the x-y plane. The initial signal of the mixer can have its maximum either above or below the time axis on the oscilloscope when the net magnetization of the sample has been driven to  $-M_0$  by the A pulse. As the direction of the net magnetization changes from below ( $-z$ ) to above ( $+z$ ) the x-y plane, the mixer signal will reverse its orientation around the time axis of the oscilloscope. If you have truly caught the moment when the net magnetization is in the x-y plane, both the pick up signal and the mixer signal will be 0. The way this time can be used to give a very good estimate of  $T_1$  is discussed in the PNMR manual.

### An Interesting Activity

With the pulse series for determining  $T_2$  on the oscilloscope screen, change one of the gradient settings so that the magnetic field at the sample becomes less homogeneous. Notice that although the widths of the individual echo traces narrow, the maximum heights of the peaks do not change. This shows that although the time for the spins to dephase due to inhomogeneity does decrease, the true time for the spins to return to their thermal equilibrium value, as indicated by the decay of the peaks, does not.